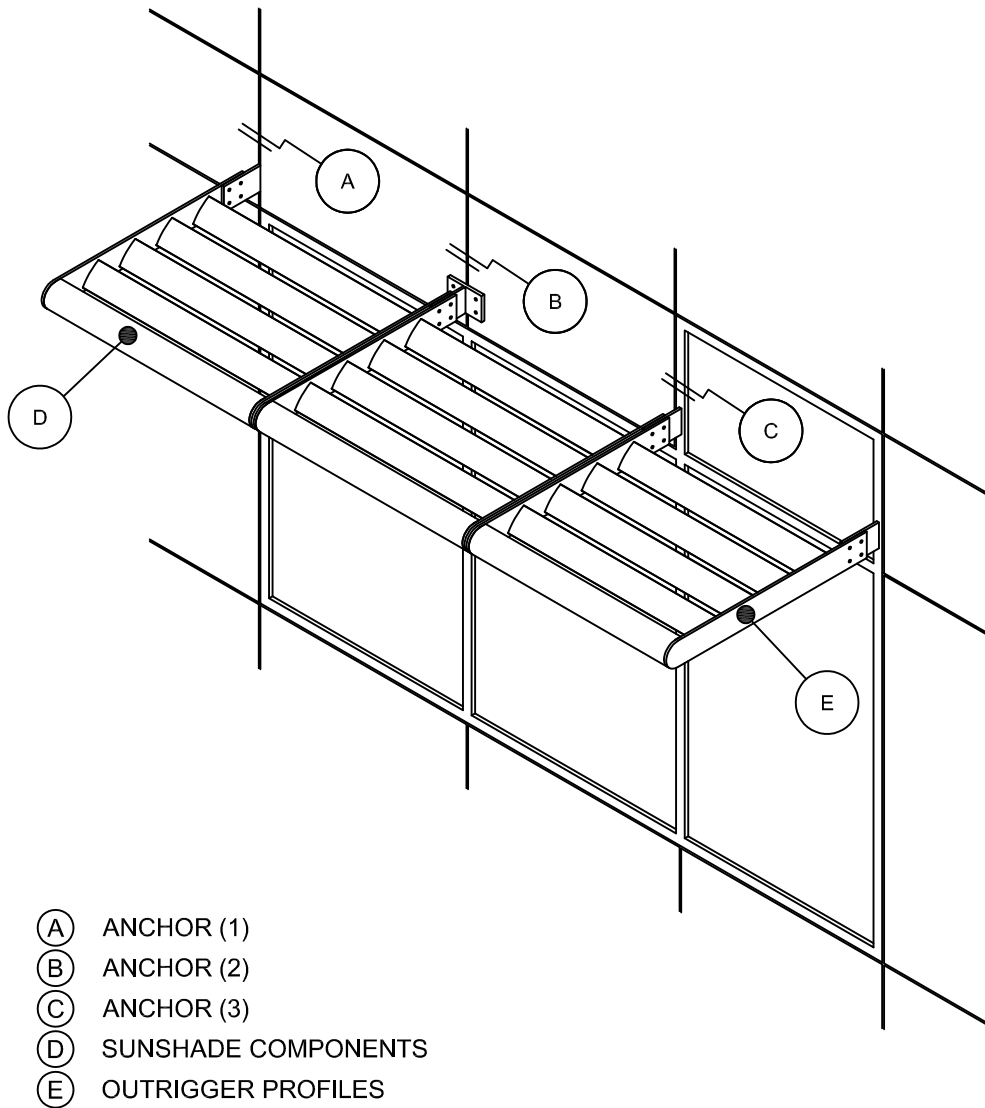

EXTERIOR SUN CONTROL DEVICE (BAR BLADES)

ANCHOR (1)

DETAIL A

NOTE:

LOAD BEARING WALL COMPONENTS OF EITHER: 16GA STEEL STUDS, STRUCTURAL MEMBERS, MINIMUM 5/8" PLYWOOD OR CONCRETE. GYPSUM BOARD AND CEMENT BOARD ARE NOT A STRUCTURAL COMPONENT.

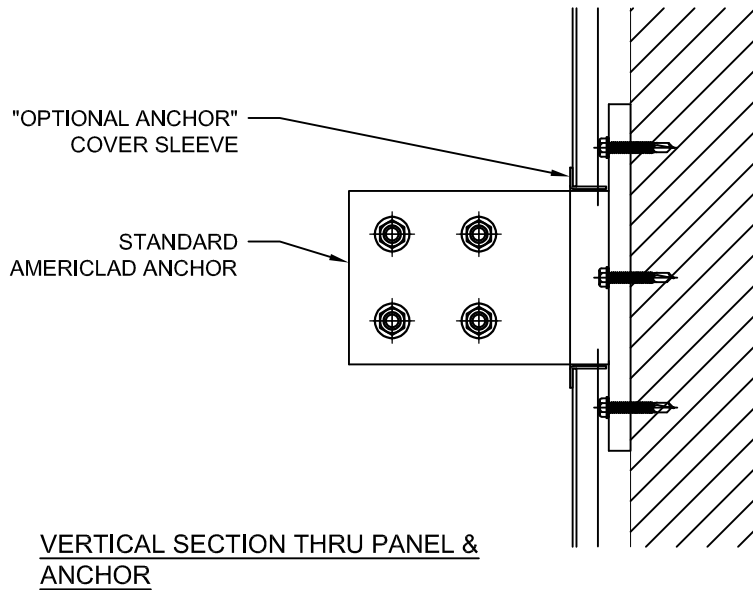
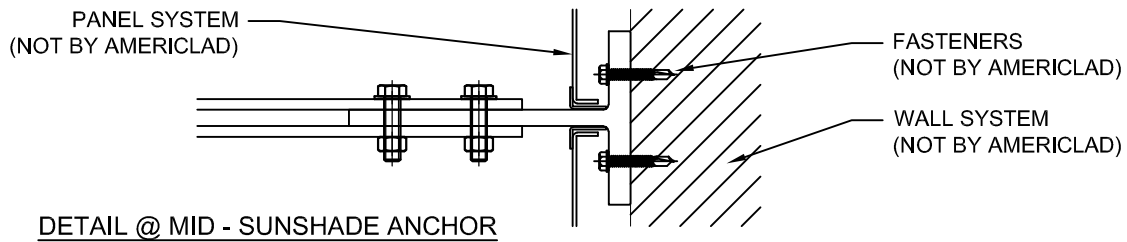
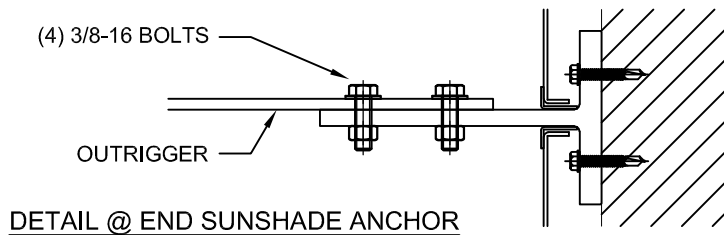

ANCHOR (2)

DETAIL B

NOTE:

LOAD BEARING WALL COMPONENTS OF EITHER: 16GA STEEL STUDS, STRUCTURAL MEMBERS, MINIMUM 5/8" PLYWOOD OR CONCRETE. GYPSUM BOARD AND CEMENT BOARD ARE NOT A STRUCTURAL COMPONENT.

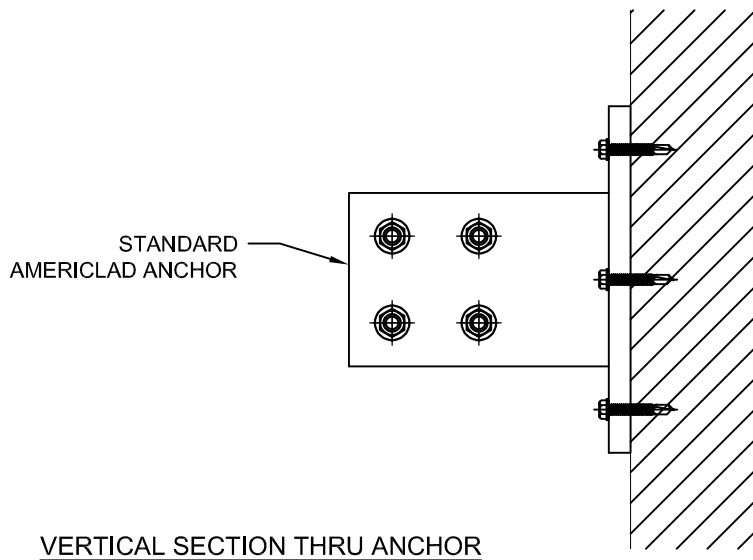
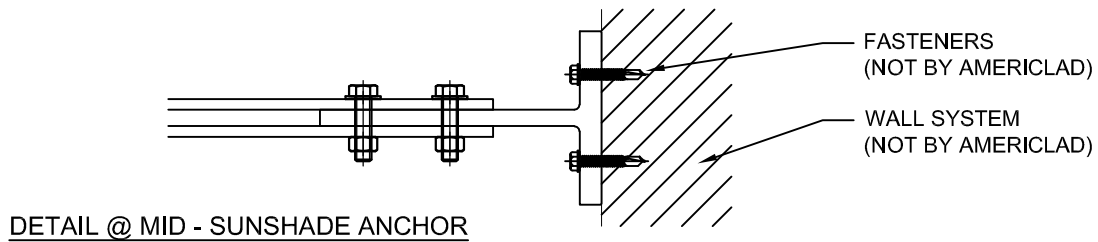
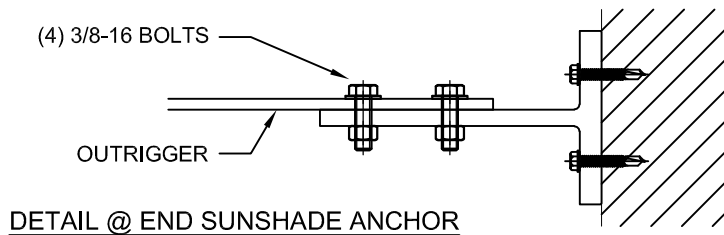

ANCHOR (3)

DETAIL C

NOTE:

LOAD BEARING WALL COMPONENTS OF EITHER: 16GA STEEL STUDS, STRUCTURAL MEMBERS, MINIMUM 5/8" PLYWOOD OR CONCRETE. GYPSUM BOARD AND CEMENT BOARD ARE NOT A STRUCTURAL COMPONENT.

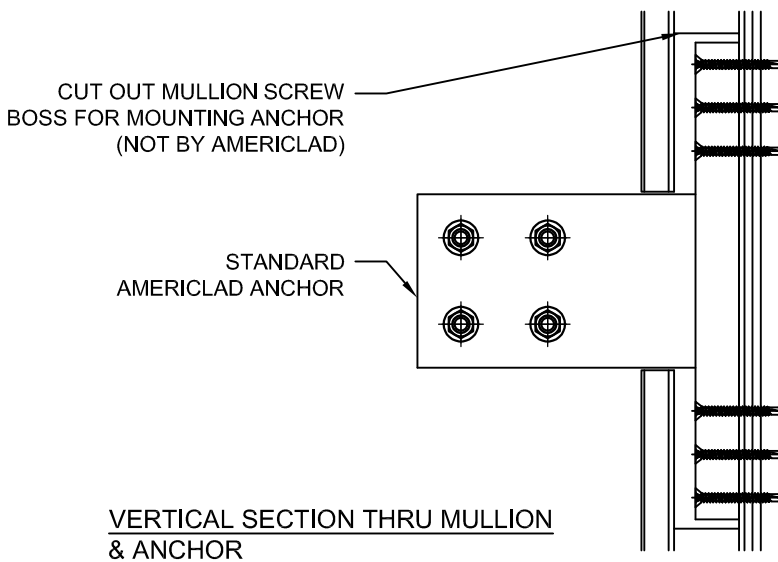
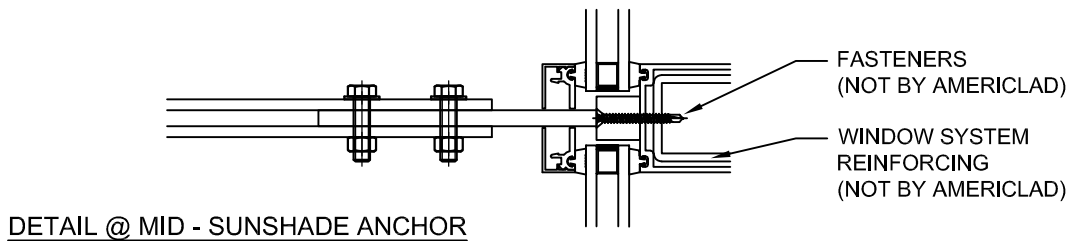
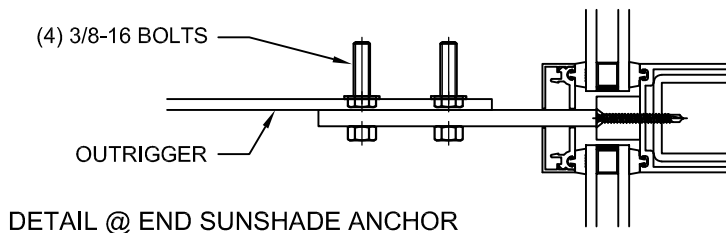

SUNSHADE COMPONENTS

DETAIL D

NOTE:

LOAD BEARING WALL COMPONENTS OF EITHER: 16GA STEEL STUDS, STRUCTURAL MEMBERS, MINIMUM 5/8" PLYWOOD OR CONCRETE. GYPSUM BOARD AND CEMENT BOARD ARE NOT A STRUCTURAL COMPONENT.

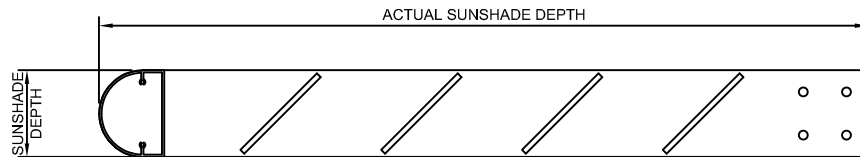

STANDARD AIRFOILS

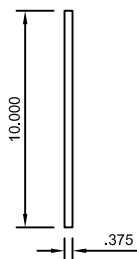
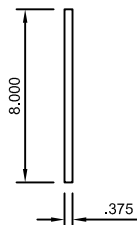
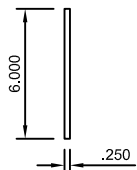
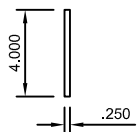

STANDARD FASCIAS

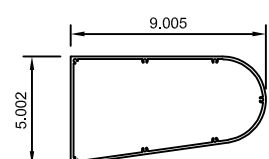
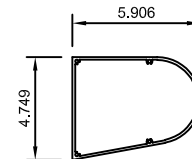
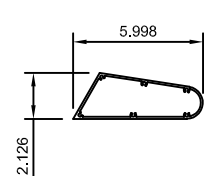
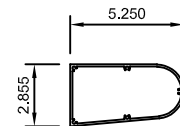
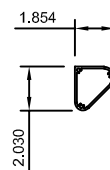
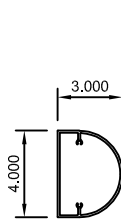
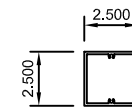
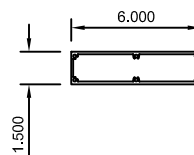
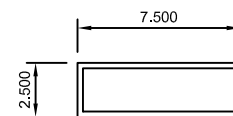
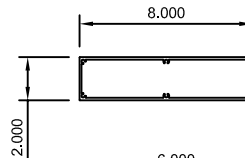
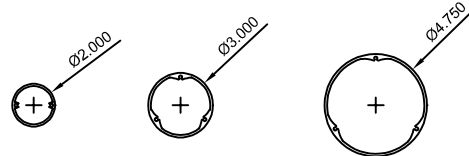

CUSTOM SIZES ARE ALSO AVAILABLE UPON REQUEST

OUTRIGGER PROFILES

DETAIL E

NOTE:

LOAD BEARING WALL COMPONENTS OF EITHER: 16GA STEEL STUDS, STRUCTURAL MEMBERS, MINIMUM 5/8" PLYWOOD OR CONCRETE. GYPSUM BOARD AND CEMENT BOARD ARE NOT A STRUCTURAL COMPONENT.

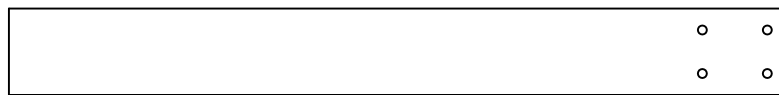

BOX OUTRIGGER

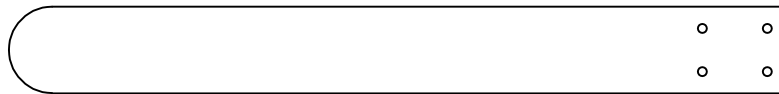

ROUND OUTRIGGER



QUARTER ROUND OUTRIGGER

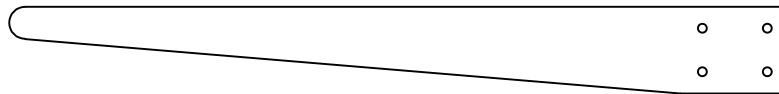

TAPER QUARTER ROUND OUTRIGGER



TAPER BOX OUTRIGGER