

FLUSH PANEL SYSTEM

NOTE:

LOAD BEARING WALL COMPONENTS OF EITHER: 16GA STEEL STUDS, STRUCTURAL MEMBERS, MINIMUM 5/8" PLYWOOD OR CONCRETE. GYPSUM BOARD AND CEMENT BOARD ARE NOT A STRUCTURAL COMPONENT.

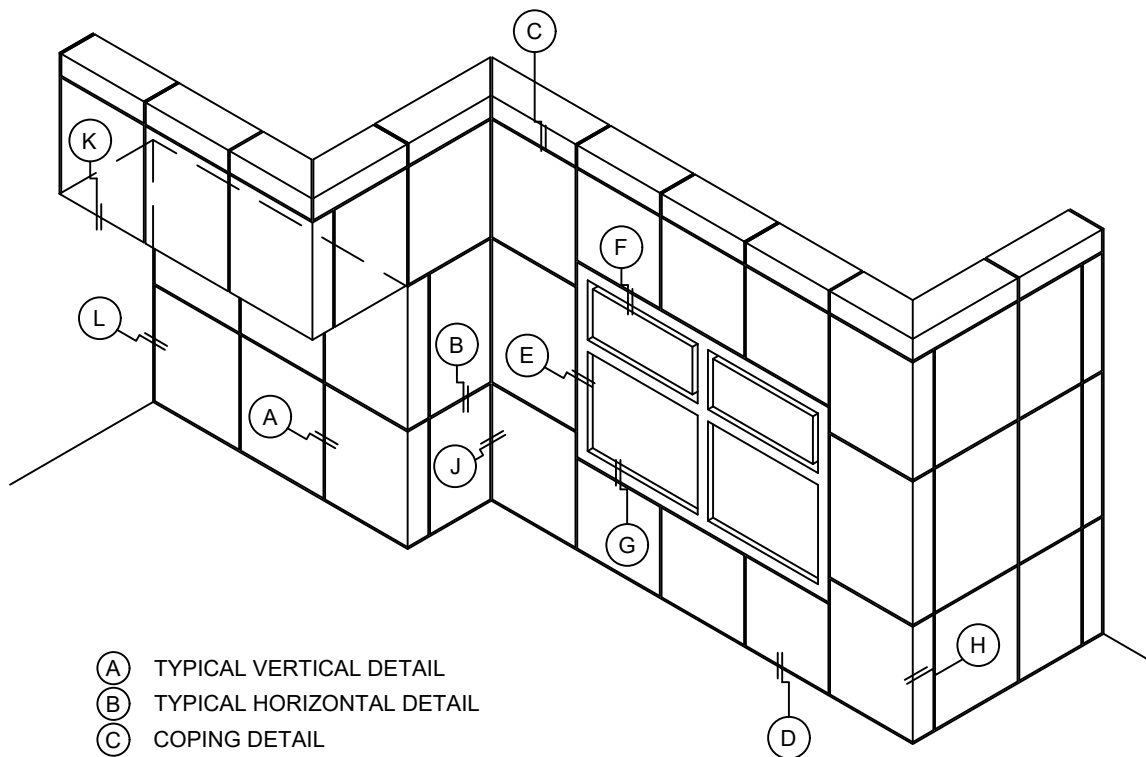

- (A) TYPICAL VERTICAL DETAIL
- (B) TYPICAL HORIZONTAL DETAIL
- (C) COPING DETAIL
- (D) BASE DETAIL
- (E) WINDOW JAMB DETAIL
- (F) WINDOW HEAD DETAIL
- (G) WINDOW SILL DETAIL
- (H) OUTSIDE CORNER DETAIL
- (J) INSIDE CORNER DETAIL
- (K) SOFFIT DETAIL
- (L) TERMINATION DETAIL

TYPICAL VERTICAL DETAIL

DETAIL A

NOTE:

LOAD BEARING WALL COMPONENTS OF EITHER: 16GA STEEL STUDS, STRUCTURAL MEMBERS, MINIMUM 5/8" PLYWOOD OR CONCRETE. GYPSUM BOARD AND CEMENT BOARD ARE NOT A STRUCTURAL COMPONENT.

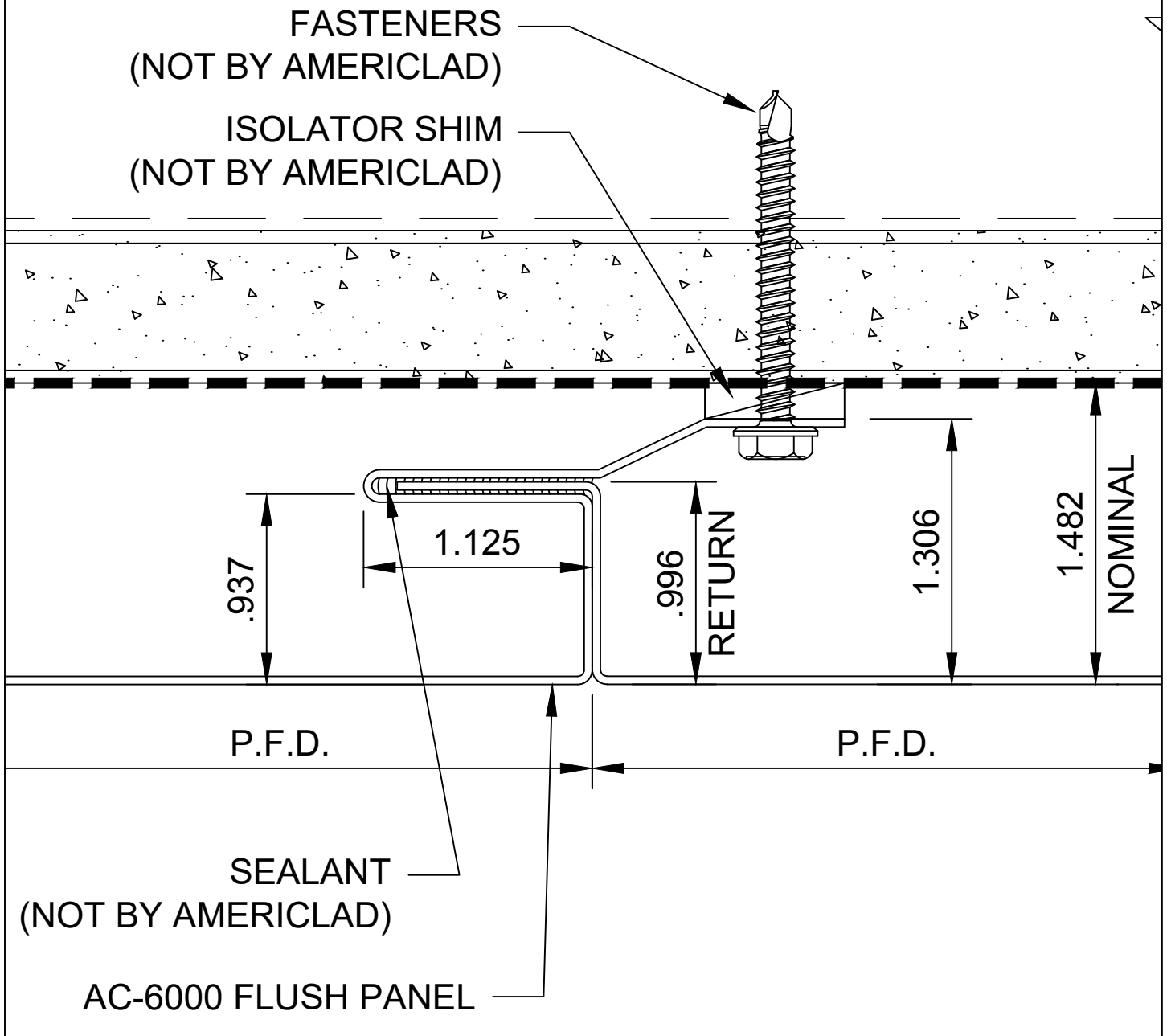

TYPICAL HORIZONTAL DETAIL

DETAIL B

NOTE:

LOAD BEARING WALL COMPONENTS OF EITHER: 16GA STEEL STUDS, STRUCTURAL MEMBERS, MINIMUM 5/8" PLYWOOD OR CONCRETE. GYPSUM BOARD AND CEMENT BOARD ARE NOT A STRUCTURAL COMPONENT.

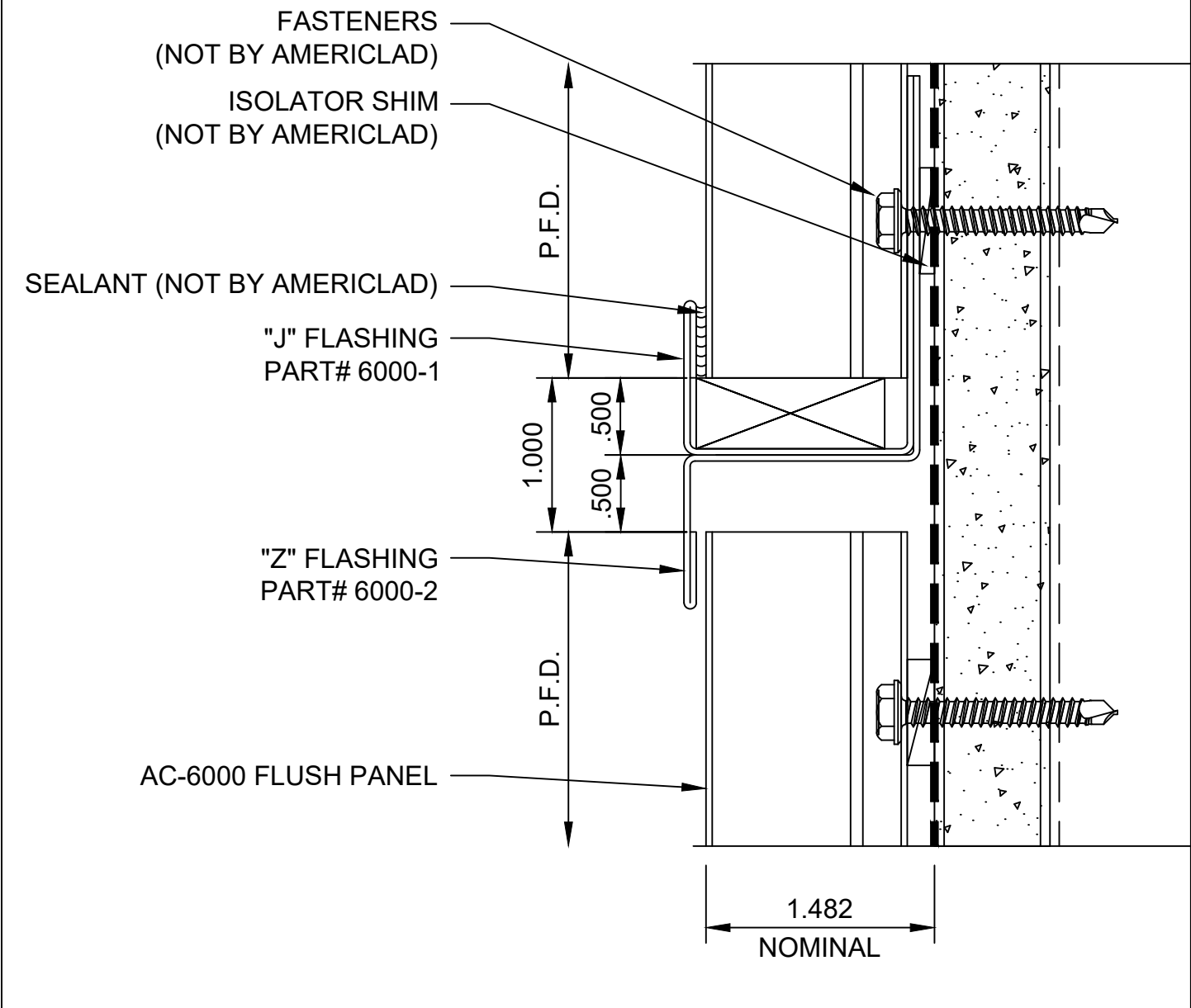

COPING DETAIL

DETAIL C

NOTE:

LOAD BEARING WALL COMPONENTS OF EITHER: 16GA STEEL STUDS, STRUCTURAL MEMBERS, MINIMUM 5/8" PLYWOOD OR CONCRETE. GYPSUM BOARD AND CEMENT BOARD ARE NOT A STRUCTURAL COMPONENT.

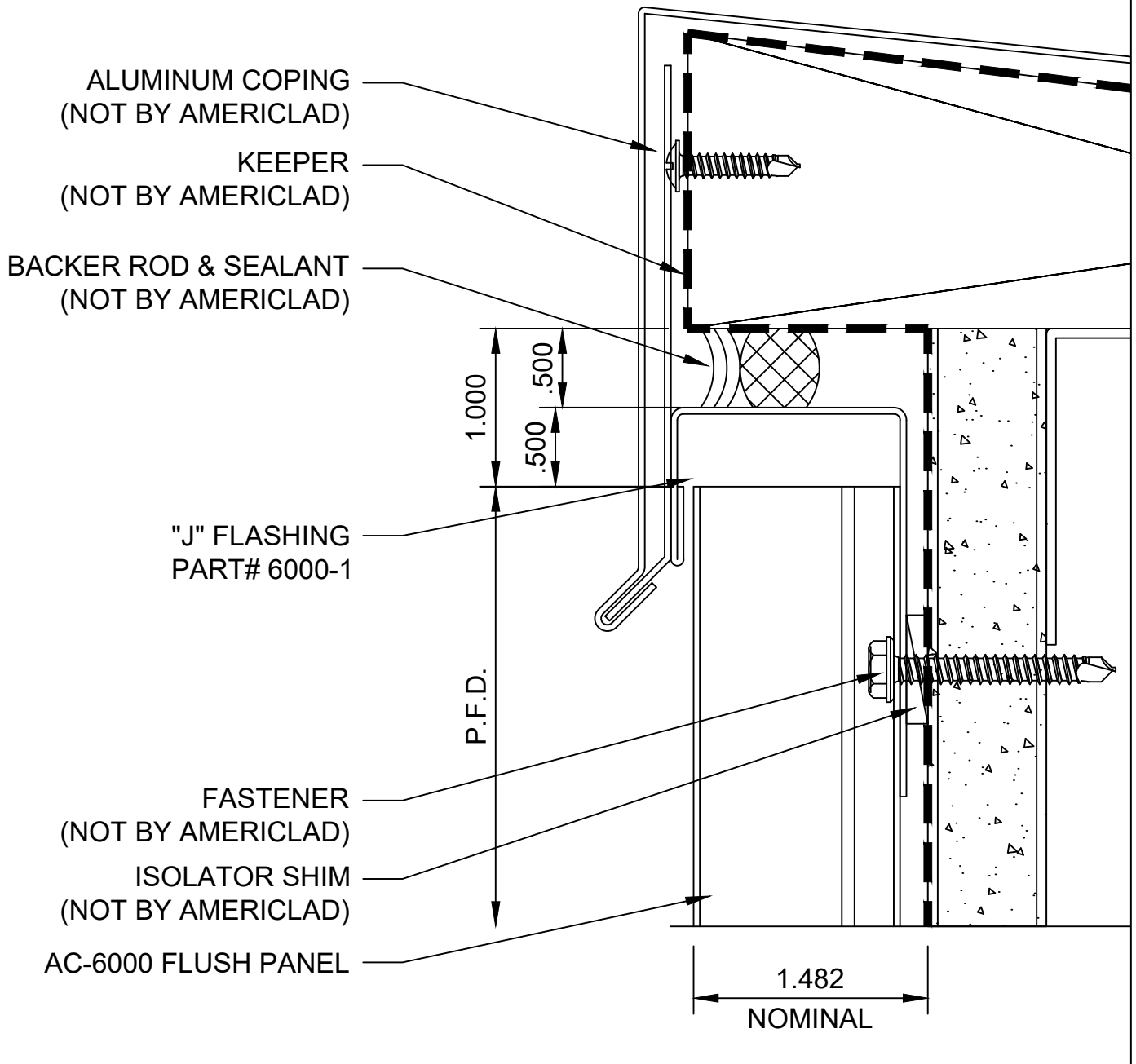

BASE DETAIL

DETAIL D

NOTE:

LOAD BEARING WALL COMPONENTS OF EITHER: 16GA STEEL STUDS, STRUCTURAL MEMBERS, MINIMUM 5/8" PLYWOOD OR CONCRETE. GYPSUM BOARD AND CEMENT BOARD ARE NOT A STRUCTURAL COMPONENT.

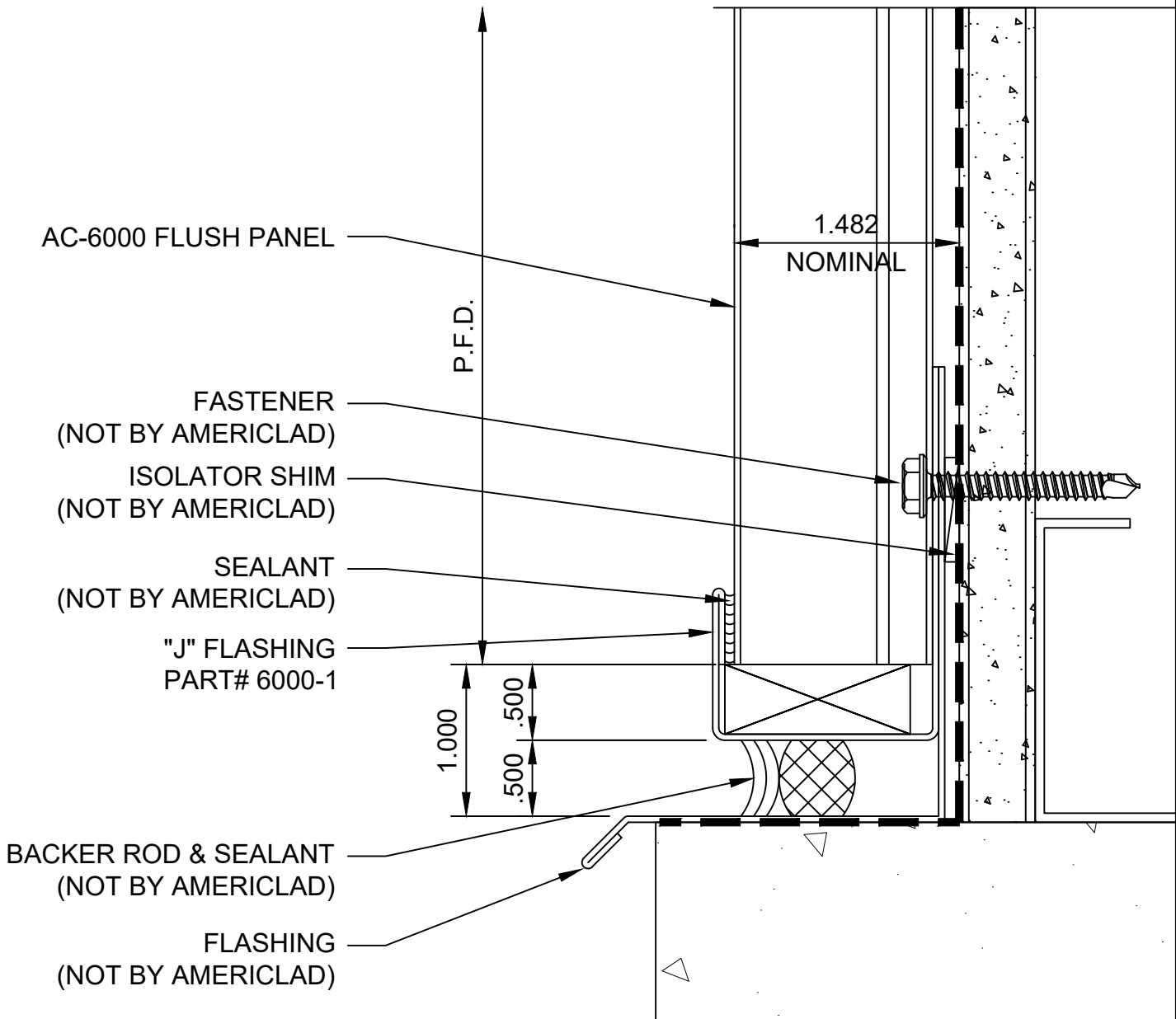

WINDOW JAMB DETAIL

DETAIL E

NOTE:

LOAD BEARING WALL COMPONENTS OF EITHER: 16GA STEEL STUDS, STRUCTURAL MEMBERS, MINIMUM 5/8" PLYWOOD OR CONCRETE. GYPSUM BOARD AND CEMENT BOARD ARE NOT A STRUCTURAL COMPONENT.

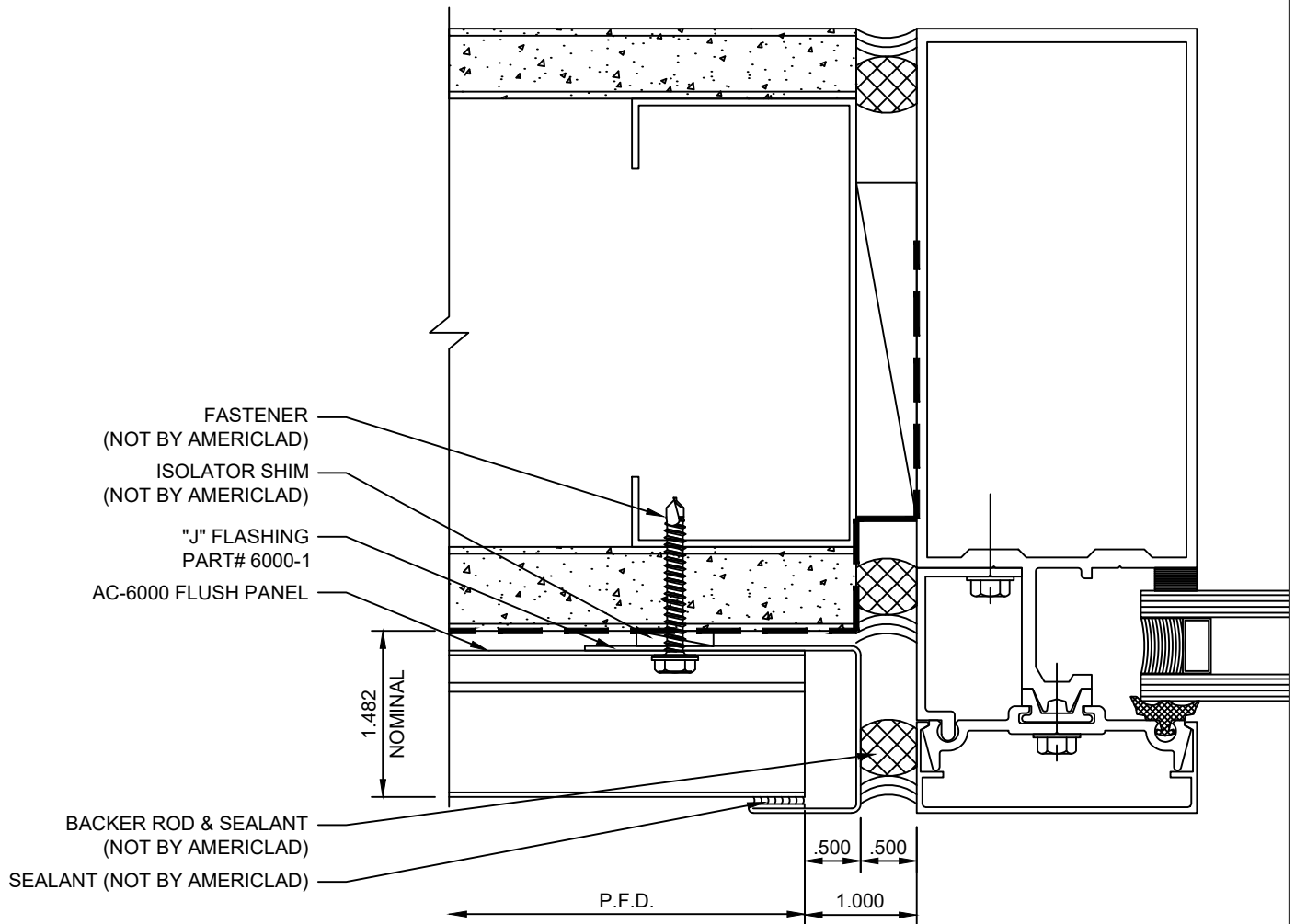

WINDOW HEAD DETAIL

DETAIL F

NOTE:

LOAD BEARING WALL COMPONENTS OF EITHER: 16GA STEEL STUDS, STRUCTURAL MEMBERS, MINIMUM 5/8" PLYWOOD OR CONCRETE. GYPSUM BOARD AND CEMENT BOARD ARE NOT A STRUCTURAL COMPONENT.

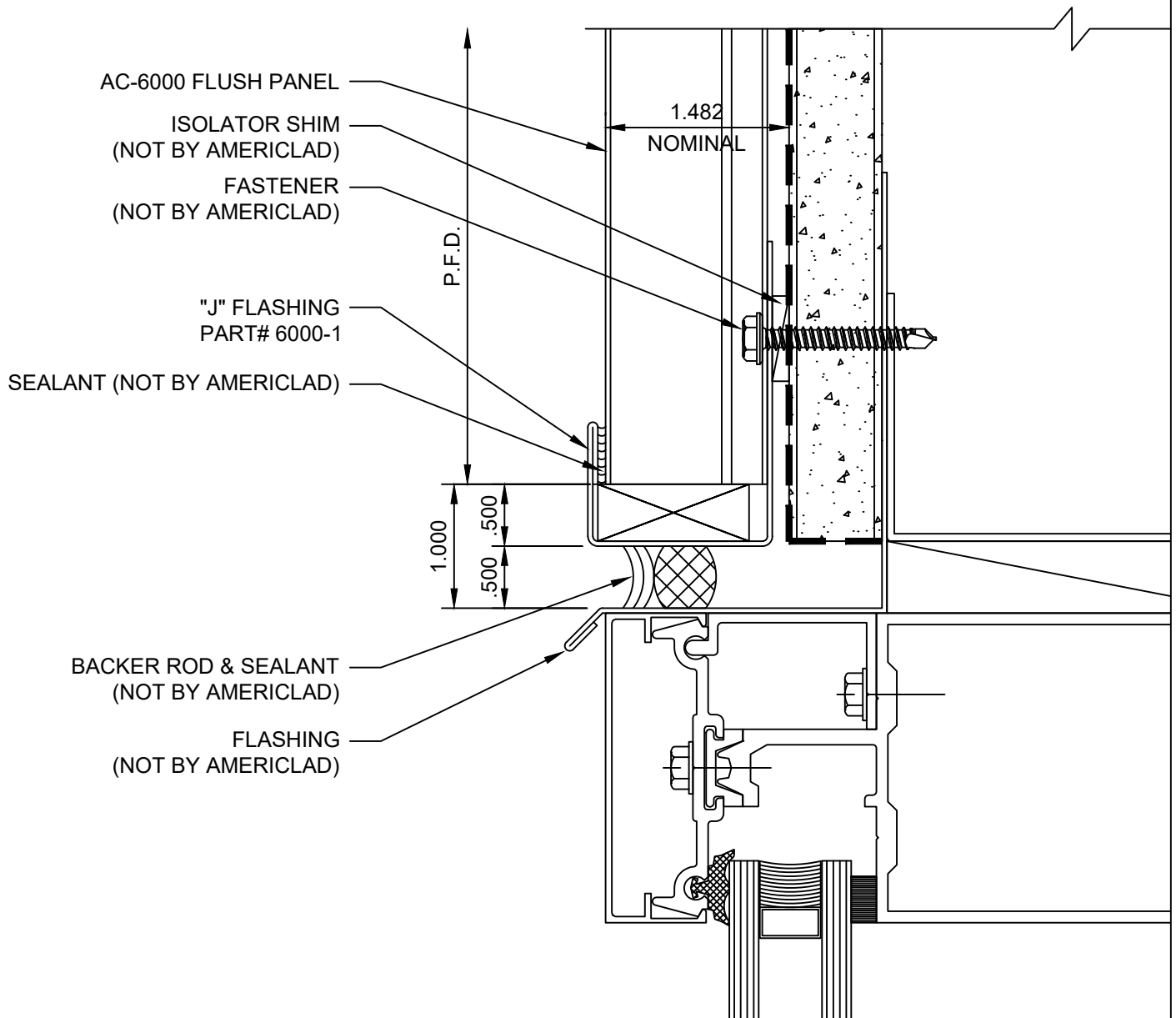

WINDOW SILL DETAIL

DETAIL G

NOTE:

LOAD BEARING WALL COMPONENTS OF EITHER: 16GA STEEL STUDS, STRUCTURAL MEMBERS, MINIMUM 5/8" PLYWOOD OR CONCRETE. GYPSUM BOARD AND CEMENT BOARD ARE NOT A STRUCTURAL COMPONENT.

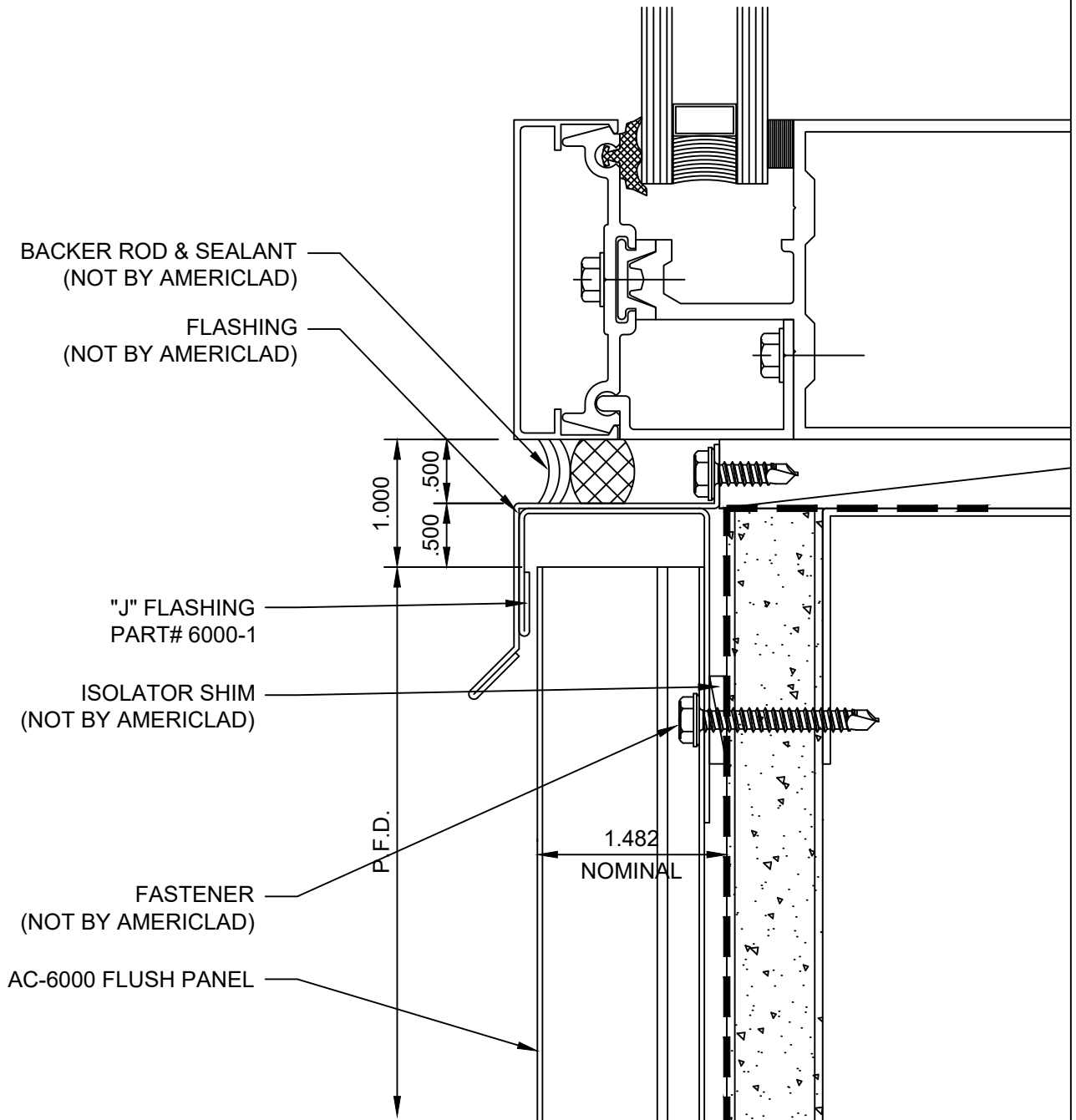

OUTSIDE CORNER DETAIL

DETAIL H

NOTE:

LOAD BEARING WALL COMPONENTS OF EITHER: 16GA STEEL STUDS, STRUCTURAL MEMBERS, MINIMUM 5/8" PLYWOOD OR CONCRETE. GYPSUM BOARD AND CEMENT BOARD ARE NOT A STRUCTURAL COMPONENT.

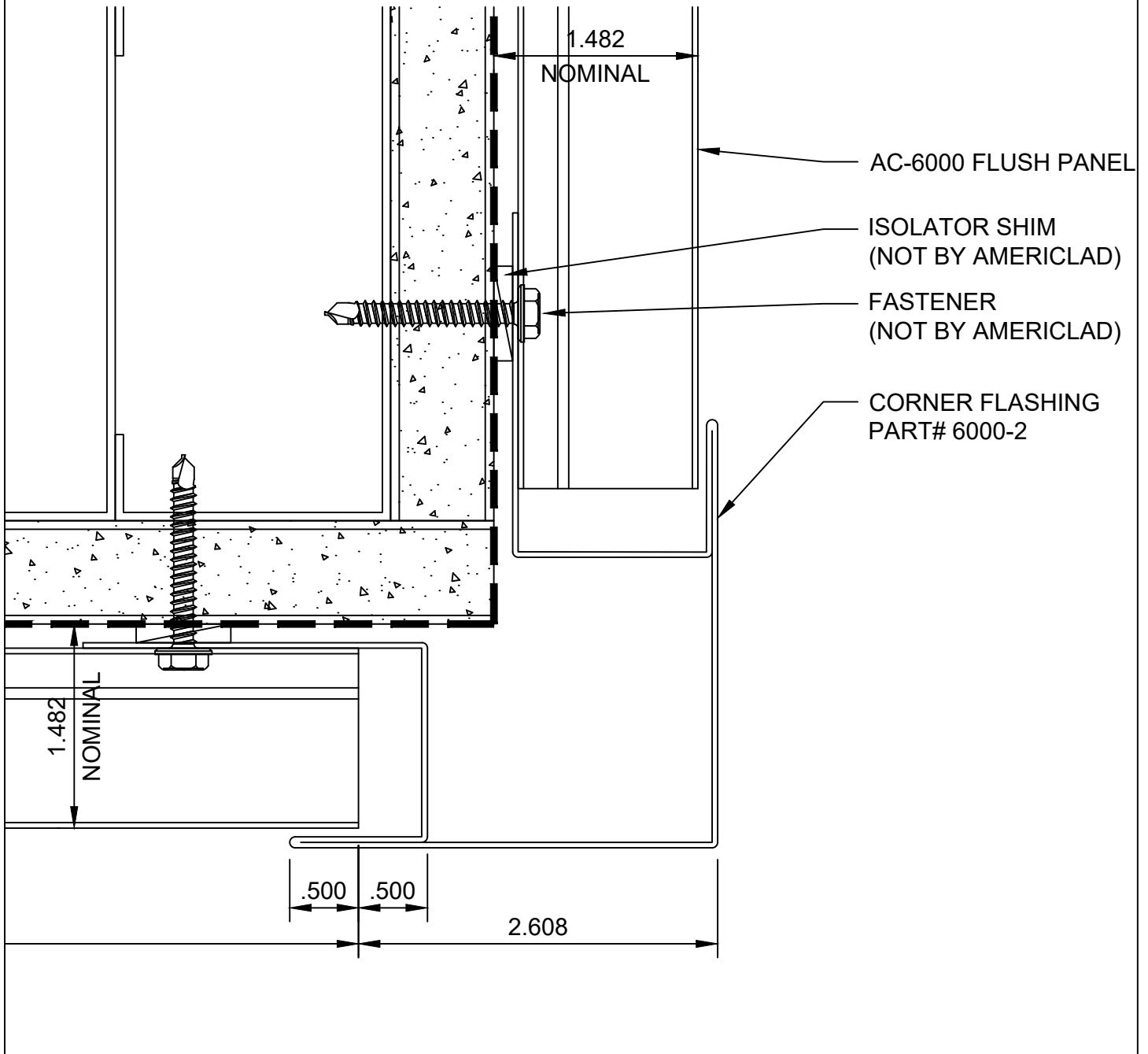

INSIDE CORNER DETAIL

DETAIL J

NOTE:

LOAD BEARING WALL COMPONENTS OF EITHER: 16GA STEEL STUDS, STRUCTURAL MEMBERS, MINIMUM 5/8" PLYWOOD OR CONCRETE. GYPSUM BOARD AND CEMENT BOARD ARE NOT A STRUCTURAL COMPONENT.

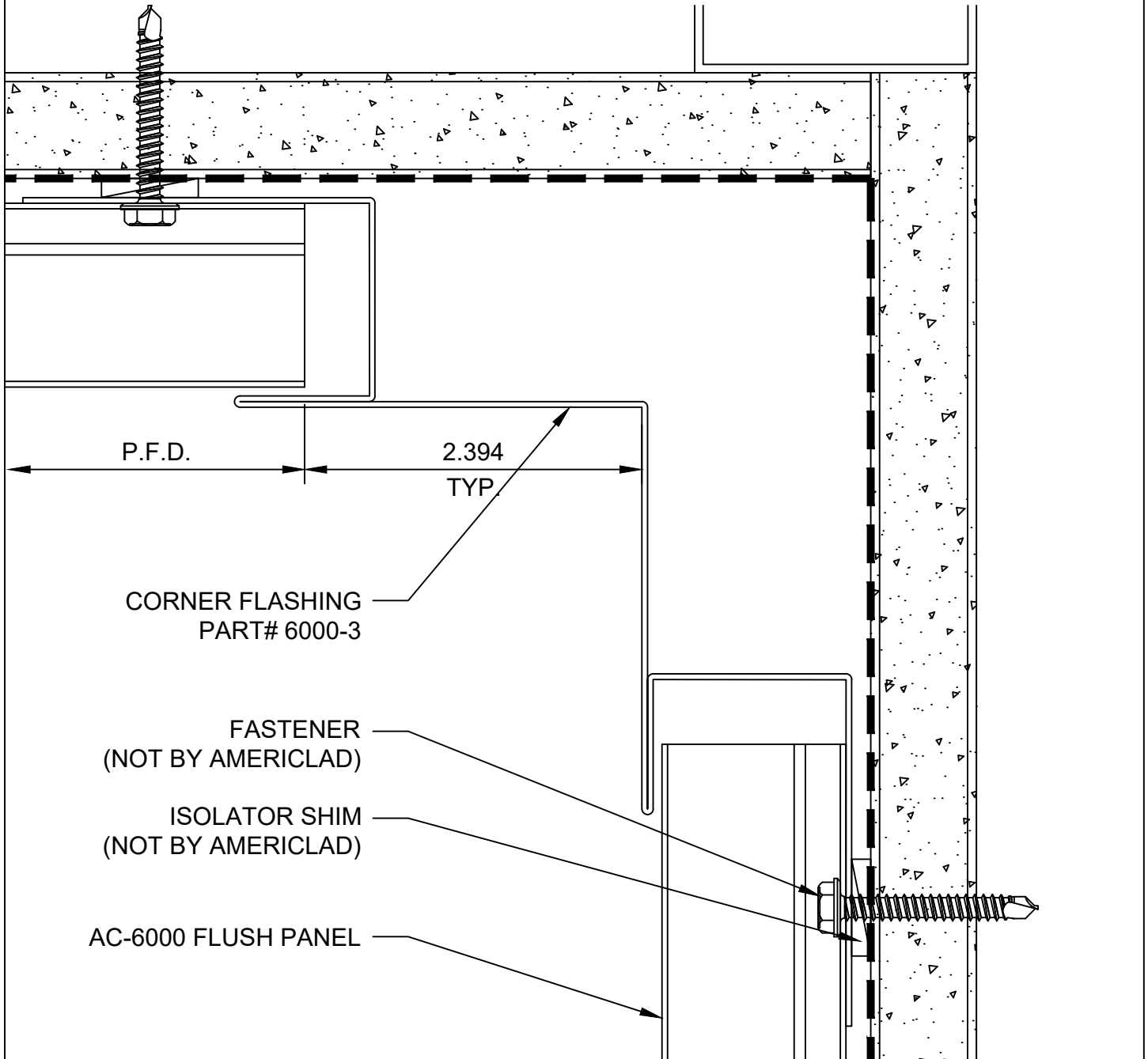

SOFFIT DETAIL

DETAIL K

NOTE:

LOAD BEARING WALL COMPONENTS OF EITHER: 16GA STEEL STUDS, STRUCTURAL MEMBERS, MINIMUM 5/8" PLYWOOD OR CONCRETE. GYPSUM BOARD AND CEMENT BOARD ARE NOT A STRUCTURAL COMPONENT.

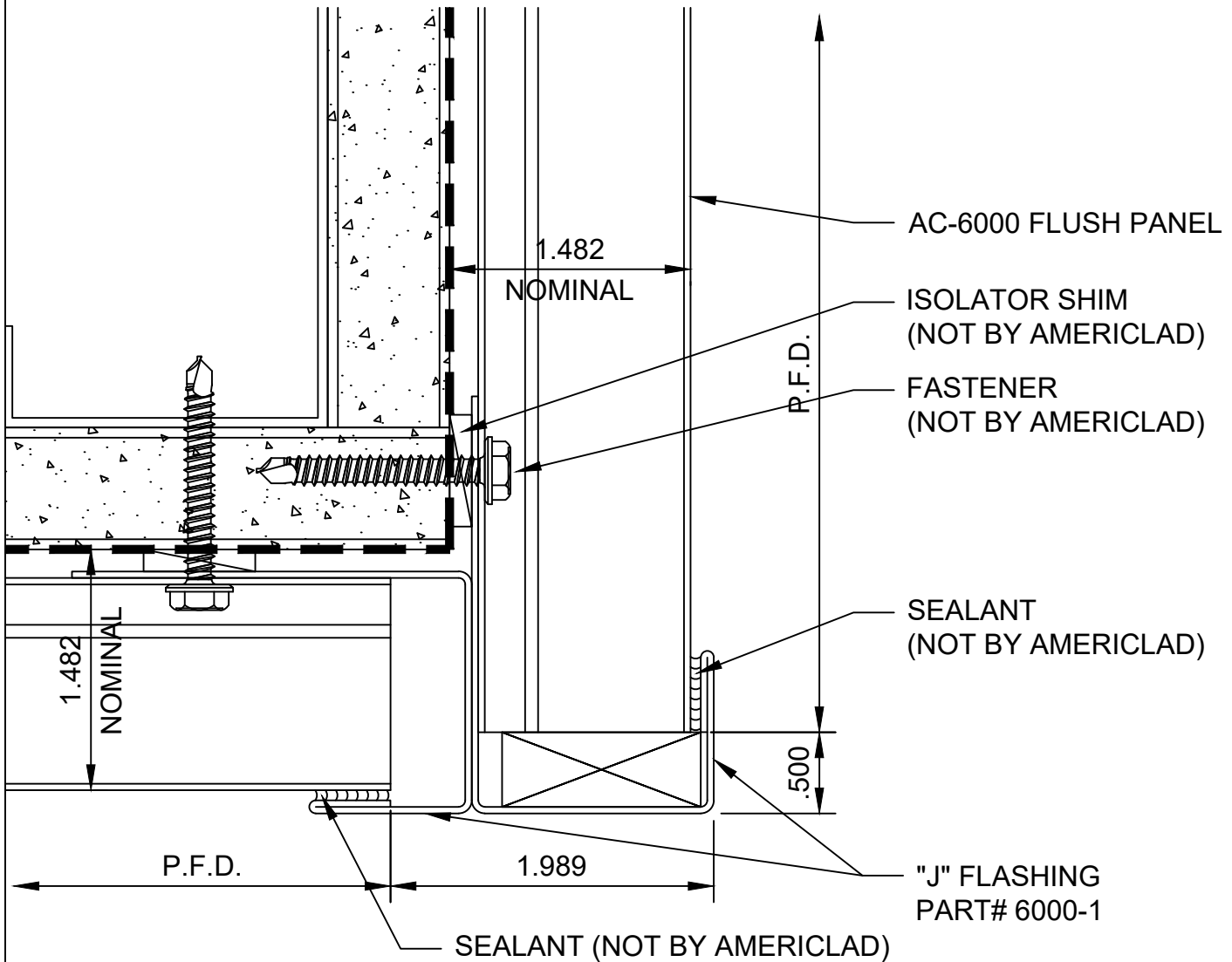

TERMINATION DETAIL

DETAIL L

NOTE:

LOAD BEARING WALL COMPONENTS OF EITHER: 16GA STEEL STUDS, STRUCTURAL MEMBERS, MINIMUM 5/8" PLYWOOD OR CONCRETE. GYPSUM BOARD AND CEMENT BOARD ARE NOT A STRUCTURAL COMPONENT.

