



AMERICLAD® AC-94BF
www.americlad.com
866-260-4047

MANUFACTURER:
Quality Metalcrafts, LLC
21925 Industrial Blvd.
Rogers, MN 55374
Telephone: (866) 260-4047
Fax: (763) 255-3399
Email: info@americlad.com

**AMERICLAD
AC-94BF
Louver**

**SECTION 08 90 00
ALUMINUM LOUVER SYSTEM
4" STATIONARY NON-DRAINABLE LOUVER WITH
FLANGE FRAME**

PART 1 – GENERAL

1.1 RELATED DOCUMENTS

- A. The drawings and provisions of the General Conditions, and the sections included under Division 1 specification sections, apply to this section

1.2 SUMMARY

- A. This section includes aluminum louvers

1.3 SUBMITTALS

- A. Product Data: Manufacturer's product literature
- B. Finish Samples: submit color samples for final approval
- C. Shop Drawings: submit shop drawings showing plans, sections and details

1.4 QUALITY ASSURANCE

- A. Manufacturer Qualifications: Minimum of five years experience in manufacturing of architectural products
- B. Installer Qualifications: Acceptable to manufacturer
- C. Production Qualifications: Louvers shall be licensed to bear AMCA Certified Ratings Seal Applies to air performance and water penetration ratings



AMERICLAD® AC-94BF
www.americlad.com
866-260-4047

1.5 DELIVERY, STORAGE AND HANDLING

- A. Delivery: deliver louvers in manufacturer's crates packed for long haul transit
- B. Storage: store materials in a dry and safe area
- C. Handling: handle materials to avoid any damage to materials and finishes

1.6 WARRANTY

- A. The contractor must warrant the materials to be free of defects in accordance with the general conditions. Finish warranty shall be extended by paint manufacturer's standard warranty
- B. Manufacturer shall provide a standard limited warranty for louver system for a period of one year from date of installation and no more than eighteen months after shipment from manufacturing plant

PART 2 – PRODUCTS

2.1 MANUFACTURER

- A. Quality Metalcrafts, LLC/AMERICLAD, 21925 Industrial Boulevard, Rogers, Minnesota 55374, Telephone: (866) 260-4047, www.americlad.com
- A. Approved equal submitted for approval 10 days prior to bid

2.2 FABRICATION

- A. Model: AC-94BF Aluminum Louver System, 4" stationary, non-drainable louver with flange frame
- B. Performance Ratings: AMCA Licensed
- C. Frame:
 - a. Depth: 4" (101.6 mm)
 - b. Material: Extruded aluminum 6063-T5
 - c. Wall Thickness: 0.081 inch (2.06 mm), nominal
 - d. Downspouts and caulking surfaces
- D. Blades:
 - a. Style: Stationary Non-drainable
 - b. Material: Extruded aluminum 6063-T5
 - c. Wall Thickness: 0.081 inch (2.06 mm), nominal
 - d. Angle: 37.5 degrees
 - e. Centers 4 inches (101.6 mm), nominal

2.3 ACCESSORIES



- A. Aluminum Sill: Provide sill flashing manufactured from same material and finish as louvers where indicated on drawings
- B. Screens: provide framed removable screens for exterior louvers
 - a. Bird Screens
 - b. Insect Screens
 - c. Blank off Panels
 - i. Insulated
 - ii. Non-insulated

2.4 FINISHES

A. Paint:

- 1. Coating shall be a Spray Applied Fluorocarbon Resin Utilizing a 70% Kynar 500/Hylar 5000 resin
- 2. Color as selected by owner from paint manufacturer's standard colors or Custom color as specified
- 3. Material to be painted in accordance with either AAMA specification 2605 or 2604

B. Anodized:

- 1. Class I, Clear Anodic Finish: AA-M12C22A41, mechanical finish, nonspecular as fabricated. Coating to have an anodic coating of 0.7 mil (0.018 mm) thickness
- 2. Class I, Color Anodic Finish: AA-M12C22A42/A44, mechanical finish, nonspecular as fabricated. Color to be determined by Owner. Coating to have an anodic coating of 0.7 mil (0.018) thickness

PART 3 – EXECUTION

3.1 PREPARATION

- A. Coordinate drawings, diagrams, and instructions for installation

3.2 INSTALLATION

- A. Install louvers at locations as indicated on the drawings and in accordance with the manufacturer's instructions
- B. Install louvers plumb, level, in plane of wall, and in alignment with adjacent work
- C. Install joint sealants as specified in section 07 90 00

3.3 CLEANING AND PROTECTION

- A. Clean exposed surfaces after installation per manufacturer's recommendation



AMERICLAD® AC-94BF
www.americlad.com
866-260-4047

- B. Touch up minor abrasions in finish with touch up paint supplied by finish applicator

END OF SECTION



21925 Industrial Blvd.
 Rogers, MN 55374
 866-260-4047
 www.americlad.com

AC-94BF DRAINABLE STATIONARY LOUVER
 FLANGE FRAME

STANDARD CONSTRUCTION

FRAME

- 4" deep, 6063-T5 extruded aluminum with a .081" nominal wall thickness

BLADES

- 6063-T5 extruded aluminum with a .081" nominal wall thickness
- Blades are positioned at a 37.5° angle and spaced approximately 4" centers

SCREEN

- .5" x .051" thick, aluminum flattened expanded metal bird screen in a removable frame
- Screen will add approximately 0.5" to the overall louver depth

FINISH

- Mill Finish

MINIMUM LOUVER SIZE

- 12" wide x 12" high

MAXIMUM LOUVER SIZE

- 70 square feet per section
- Single section size not to exceed 120" wide x 84" high or 84" wide x 120" high
- Louvers exceeding the maximum single section size will be built in multiple sections and require field assembly

BLADE BRACE SUPPORT ANGLES

- Depending on louver size, wind load, or other special requirements, louvers will have rear mounted blade support angles that will increase overall louver depth

Note: Louvers built .25" smaller than opening size given

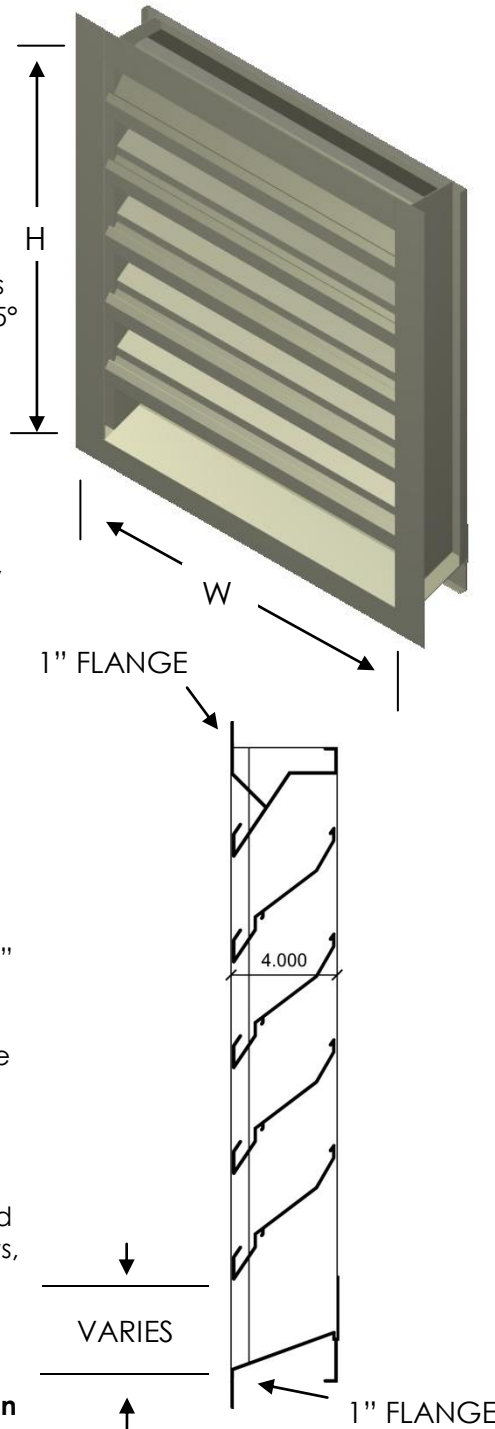

STANDARD FEATURES

- Aluminum construction, providing a high resistance to corrosion
- All welded construction for strength and durability
- 50% Free Area (based on a 48" x 48" unit)
- Drainable head collects and channels water to drainable jamb to provide excellent water penetration performance
- Drainable blade channels water to drainable jamb minimizing water cascade between blades
- Hidden mullions allow for continuous blade appearance up to 120"

OPTIONS AVAILABLE

Many optional accessories to the basic design are available at an additional cost, including:

- Sill extension/head flashing
- Hinged frame/channel subframe
- Security bars
- Filter rack
- Bird/insect screens (please refer to screen submittal)
- Blank-off panels (standard or insulated)

FINISHES

- Kynar 500/Hylar 5000
- Baked Enamel
- Prime Coat
- Anodized in various colors and shades (some color variation is possible with anodized finishes)

Contact Quality Metalcrafts, LLC / AMERICLAD® for any additional information or any special requirements



AC-94BF

LOUVER - 4 INCH W/ FLANGE & 4 INCH SPACING

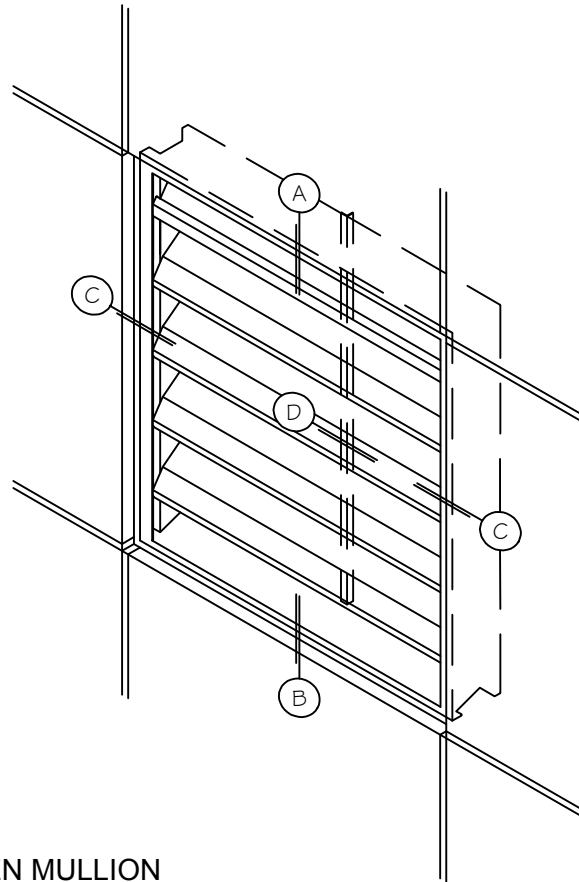

- (A) HEAD
- (B) SILL
- (C) JAMB
- (D) HIDDEN MULLION
- (E) SPECIAL SHAPE LOUVERS

COPYRIGHT QUALITY METALCRAFTS, LLC

21925 Industrial Boulevard · Rogers, Minnesota · Toll-Free: 1-866-260-4047 · americlad.com
Architectural Metal Products



AC-94BF

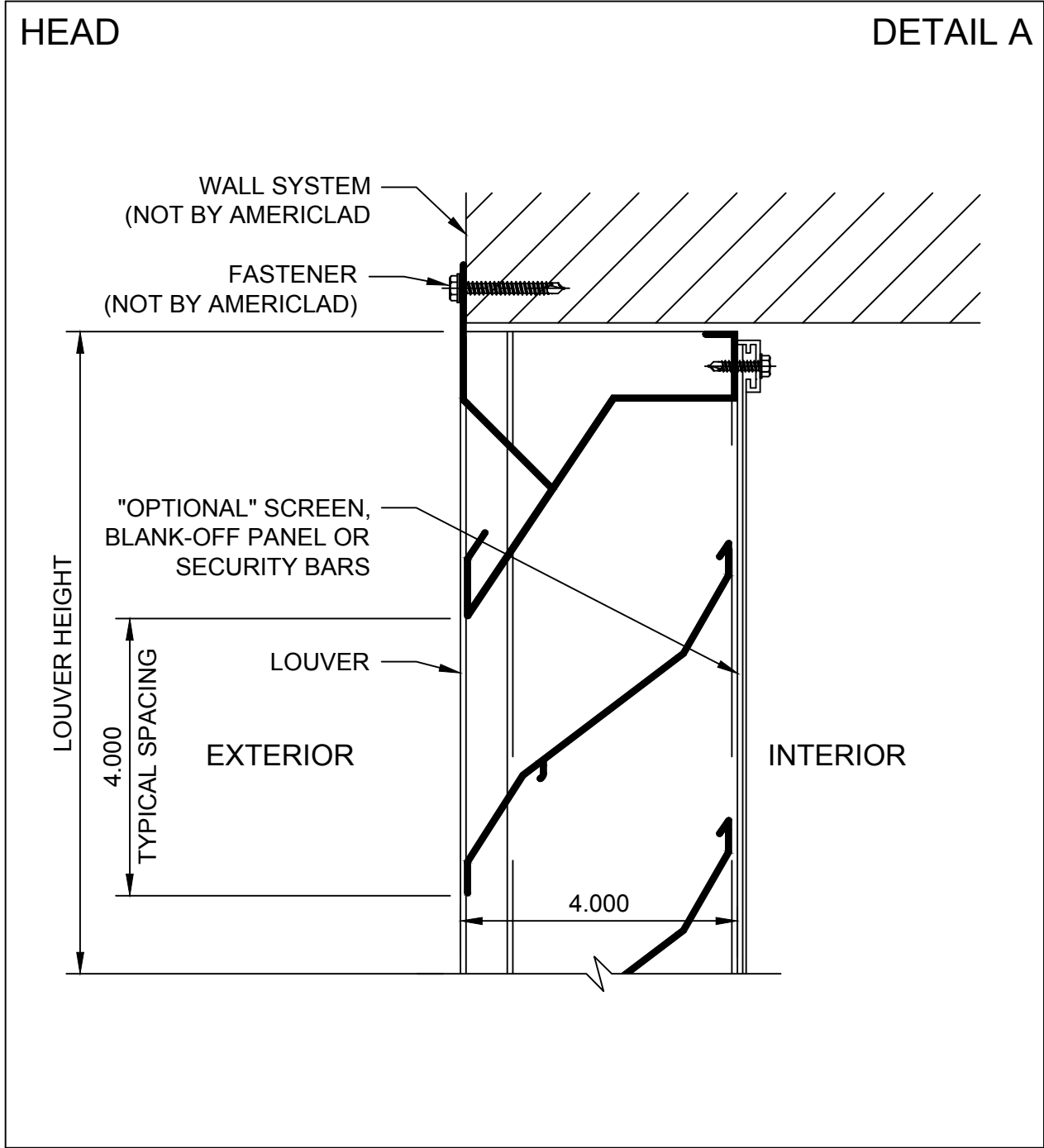

COPYRIGHT QUALITY METALCRAFTS, LLC

21925 Industrial Boulevard · Rogers, Minnesota · Toll-Free: 1-866-260-4047 · americlad.com
Architectural Metal Products



AC-94BF

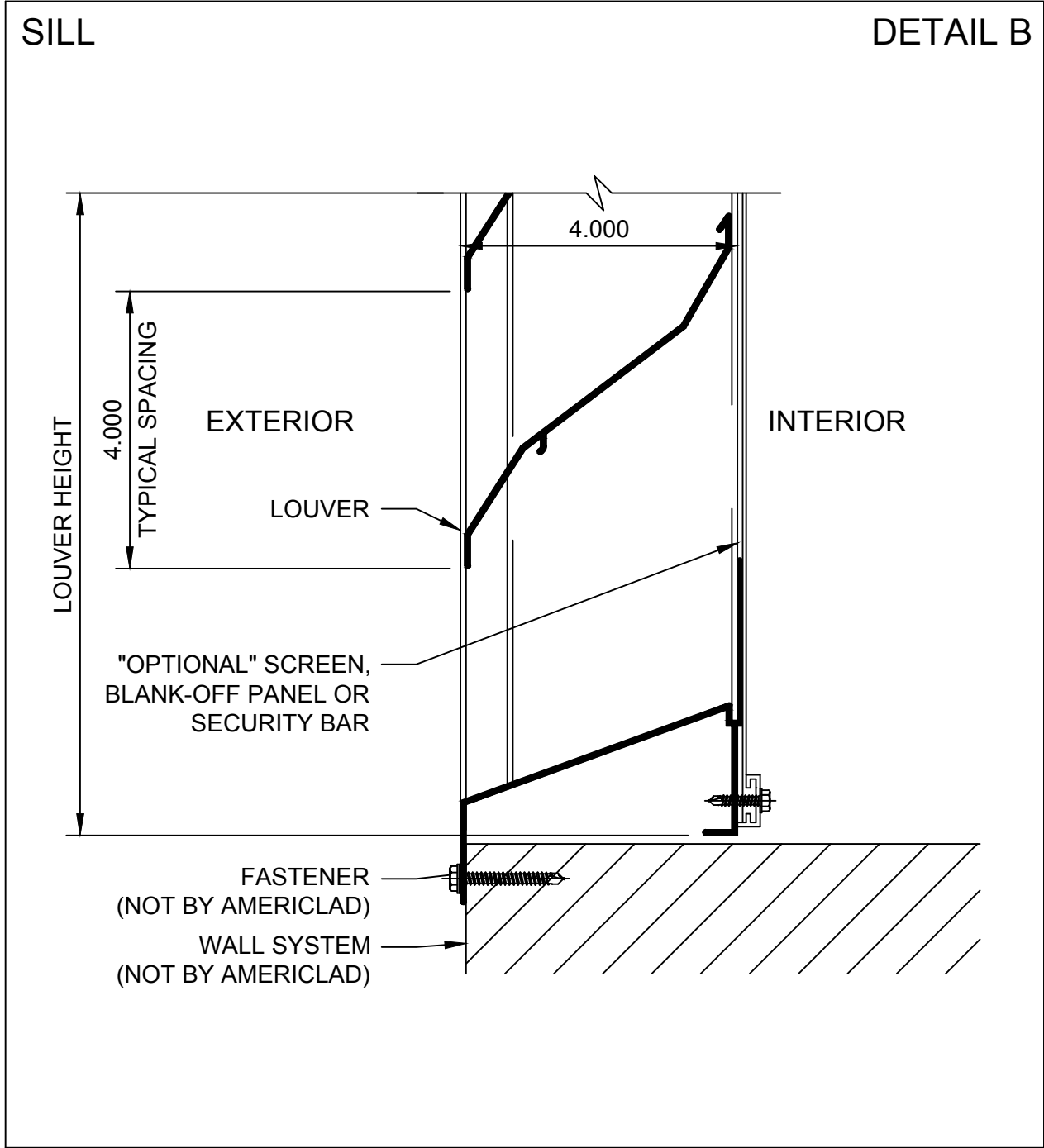

COPYRIGHT QUALITY METALCRAFTS, LLC

21925 Industrial Boulevard · Rogers, Minnesota · Toll-Free: 1-866-260-4047 · americlad.com
Architectural Metal Products



AC-94BF

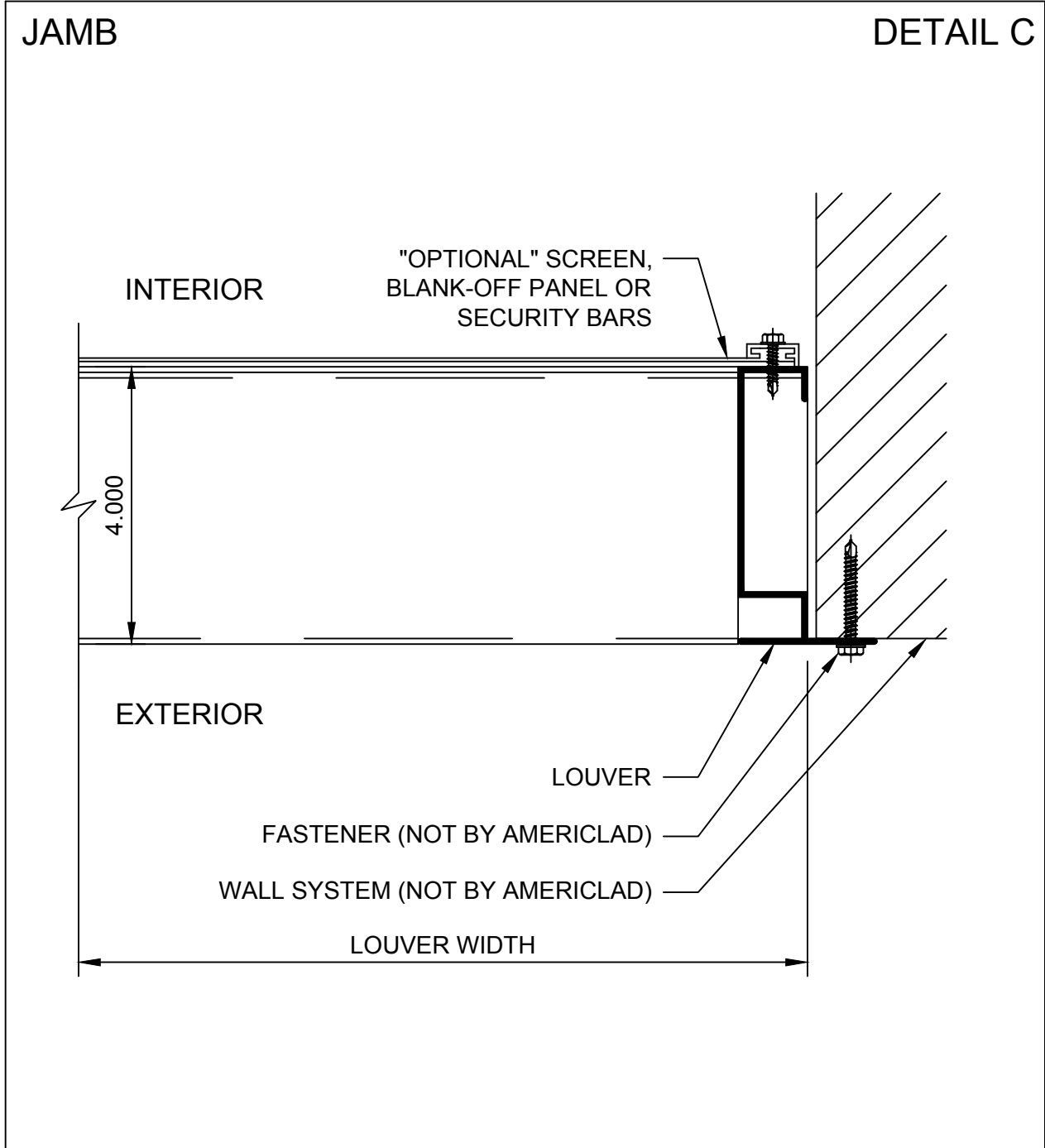

COPYRIGHT QUALITY METALCRAFTS, LLC



AC-94BF

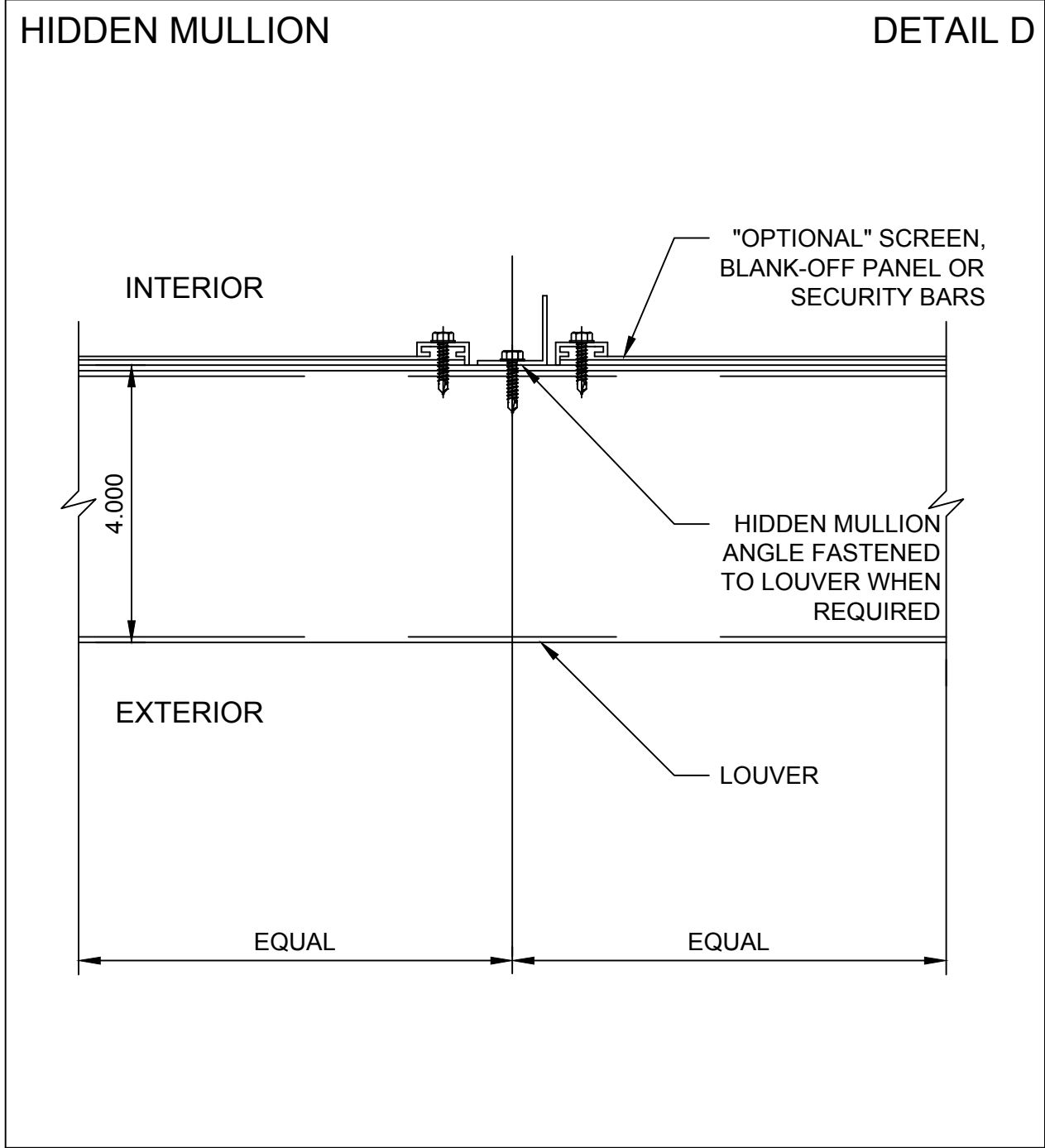

COPYRIGHT QUALITY METALCRAFTS, LLC

21925 Industrial Boulevard · Rogers, Minnesota · Toll-Free: 1-866-260-4047 · americlad.com
Architectural Metal Products



AC-94BF

SPECIAL SHAPE LOUVERS

DETAIL E

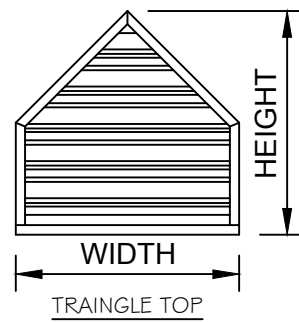
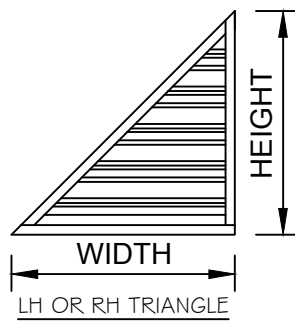
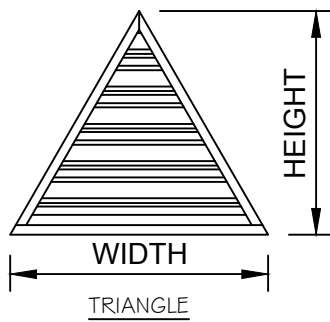
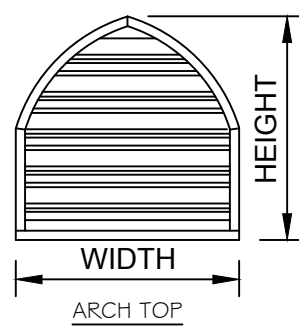
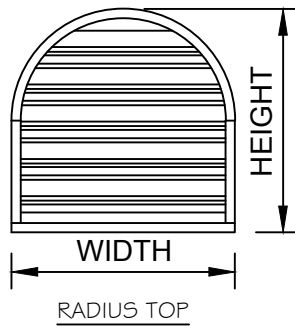
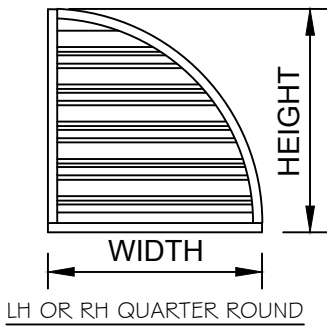
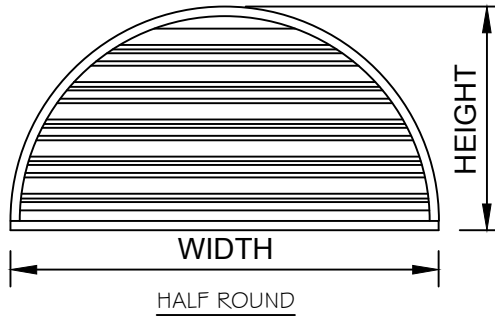
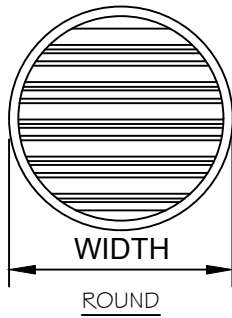

COPYRIGHT QUALITY METALCRAFTS, LLC

21925 Industrial Boulevard · Rogers, Minnesota · Toll-Free: 1-866-260-4047 · americlad.com

Architectural Metal Products