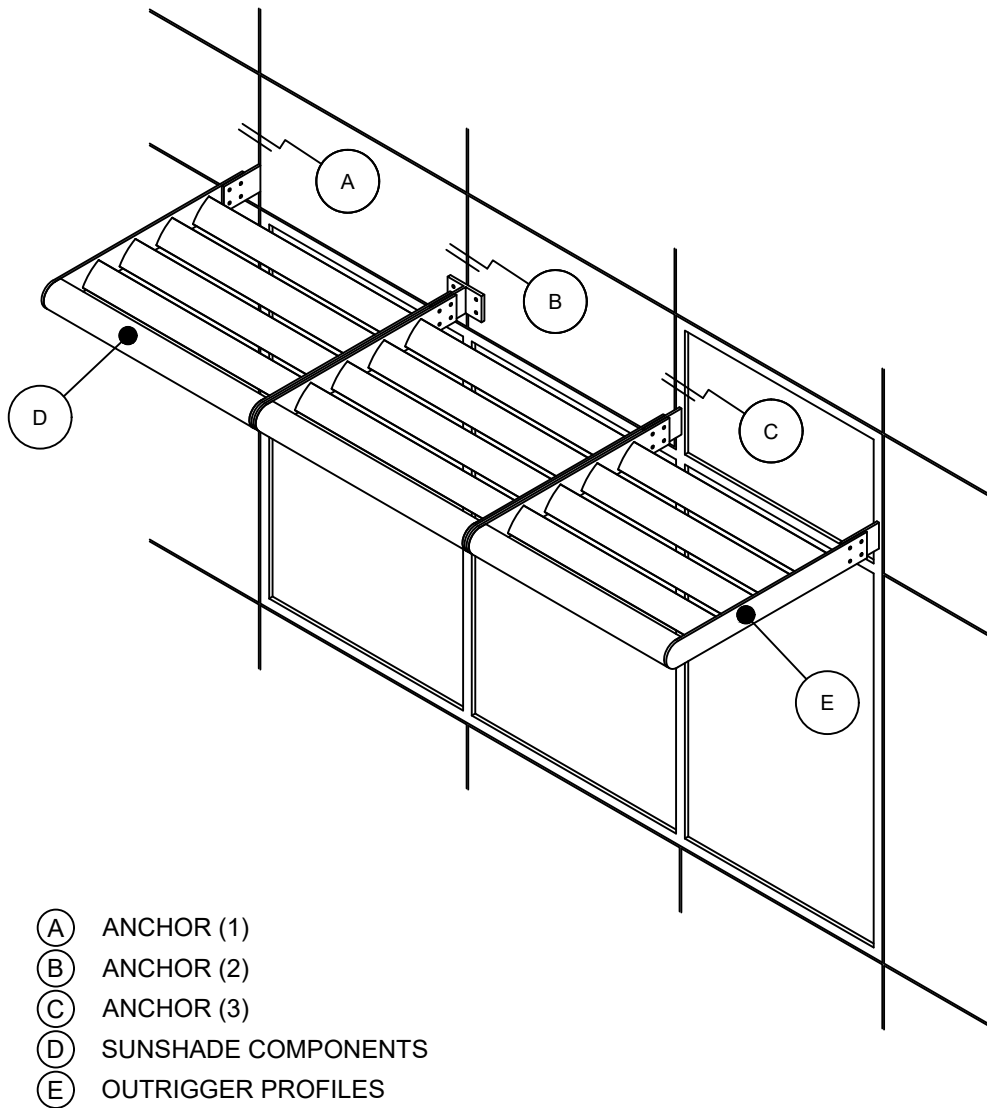

EXTERIOR SUN CONTROL DEVICE (AIRFOIL BLADES)

ANCHOR (1)

DETAIL A

NOTE:

LOAD BEARING WALL COMPONENTS OF EITHER: 16GA STEEL STUDS, STRUCTURAL MEMBERS, MINIMUM 5/8" PLYWOOD OR CONCRETE. GYPSUM BOARD AND CEMENT BOARD ARE NOT A STRUCTURAL COMPONENT.

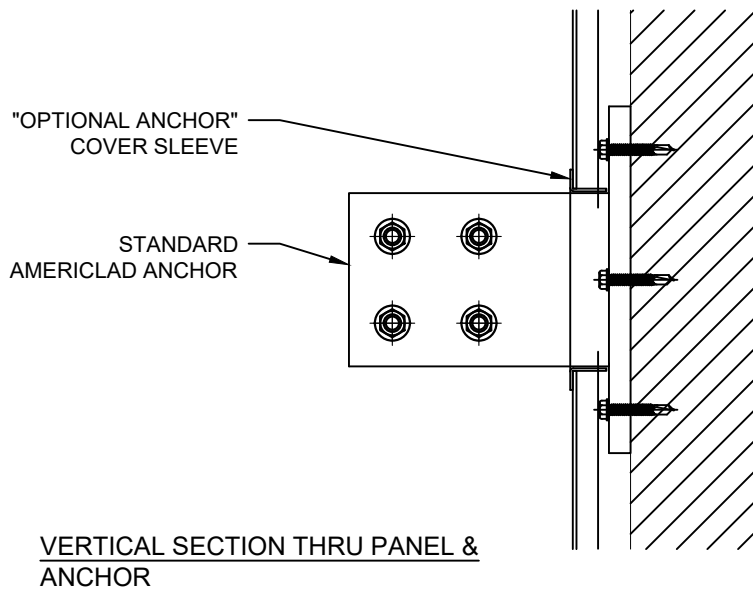
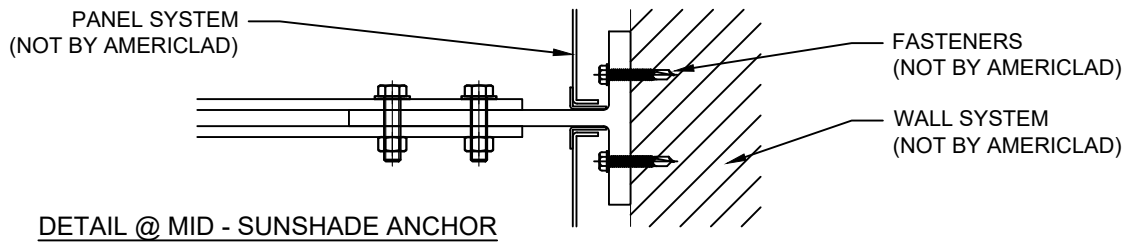
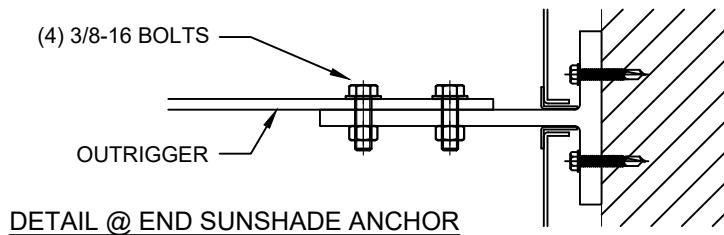

ANCHOR (2)**DETAIL B****NOTE:**

LOAD BEARING WALL COMPONENTS OF EITHER: 16GA STEEL STUDS, STRUCTURAL MEMBERS, MINIMUM 5/8" PLYWOOD OR CONCRETE. GYPSUM BOARD AND CEMENT BOARD ARE NOT A STRUCTURAL COMPONENT.

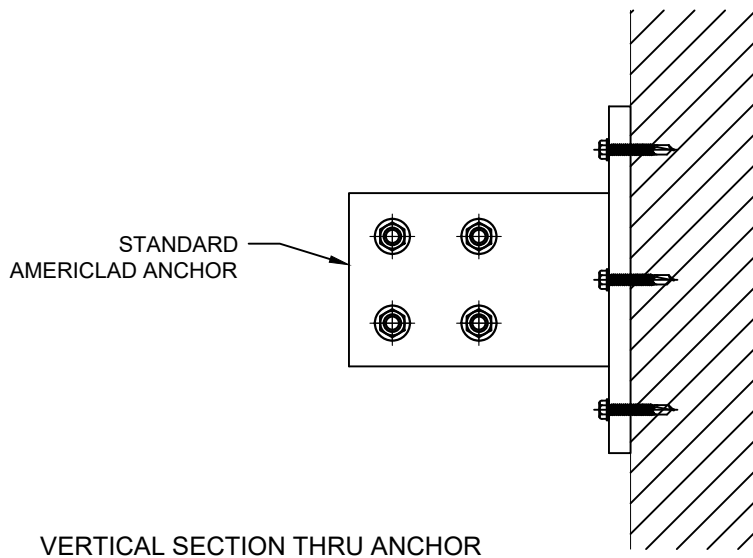
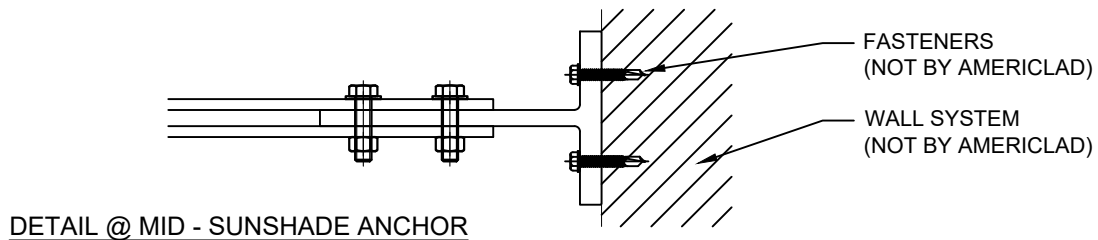
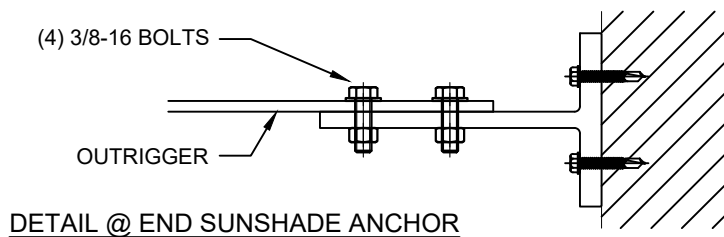

ANCHOR (3)
DETAIL C
NOTE:

LOAD BEARING WALL COMPONENTS OF EITHER: 16GA STEEL STUDS, STRUCTURAL MEMBERS, MINIMUM 5/8" PLYWOOD OR CONCRETE. GYPSUM BOARD AND CEMENT BOARD ARE NOT A STRUCTURAL COMPONENT.

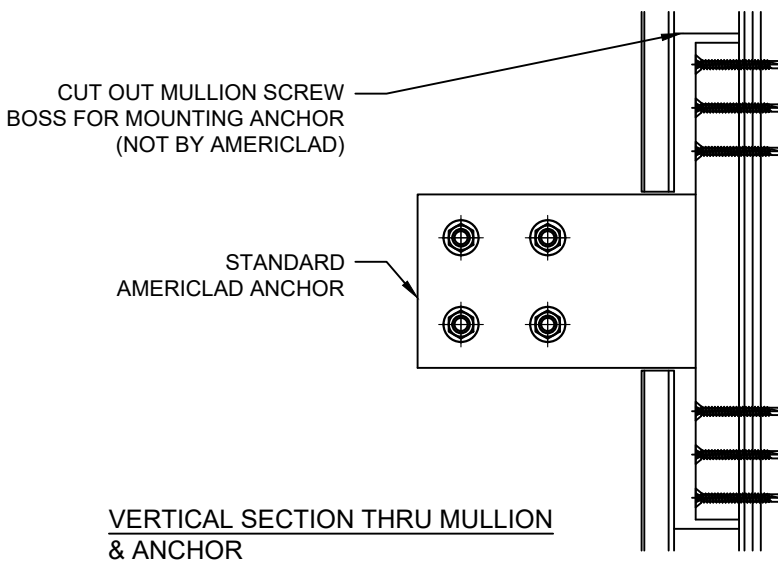
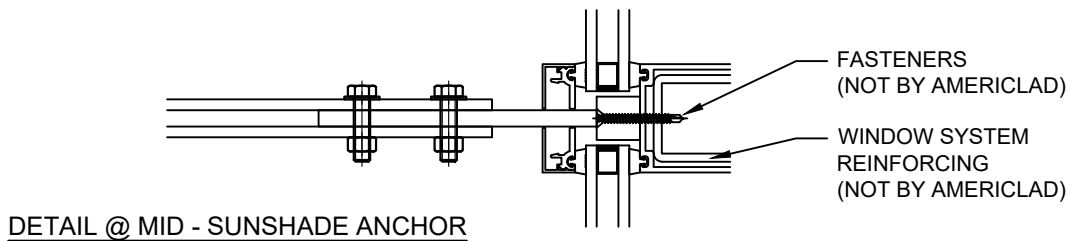
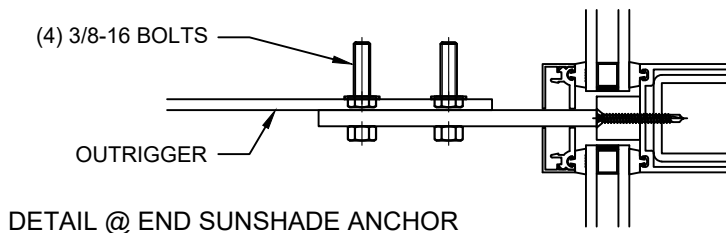

SUNSHADE COMPONENTS

DETAIL D

NOTE:

LOAD BEARING WALL COMPONENTS OF EITHER: 16GA STEEL STUDS, STRUCTURAL MEMBERS, MINIMUM 5/8" PLYWOOD OR CONCRETE. GYPSUM BOARD AND CEMENT BOARD ARE NOT A STRUCTURAL COMPONENT.

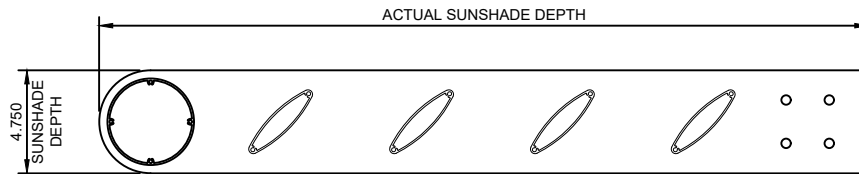

STANDARD AIRFOILS

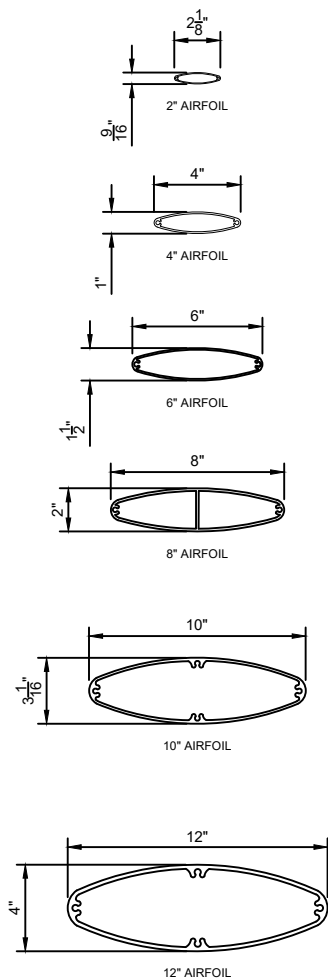

STANDARD FASCIAS

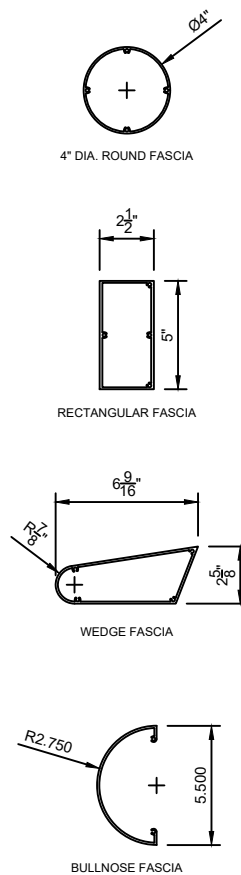

OUTRIGGER PROFILES**DETAIL E****NOTE:**

LOAD BEARING WALL COMPONENTS OF EITHER: 16GA STEEL STUDS, STRUCTURAL MEMBERS, MINIMUM 5/8" PLYWOOD OR CONCRETE. GYPSUM BOARD AND CEMENT BOARD ARE NOT A STRUCTURAL COMPONENT.

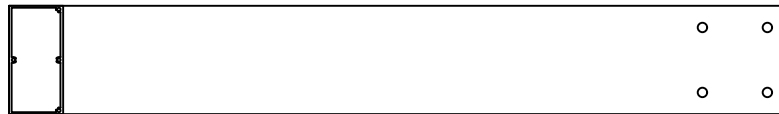

BOX OUTRIGGER

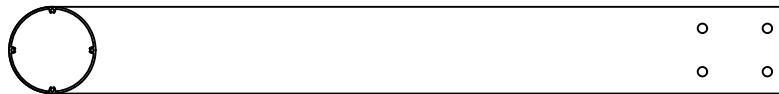

ROUND OUTRIGGER

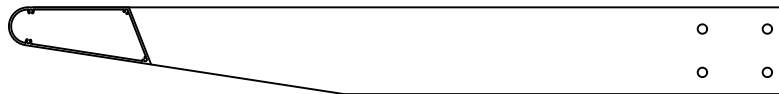

QUARTER ROUND OUTRIGGER



TAPER QUARTER ROUND OUTRIGGER

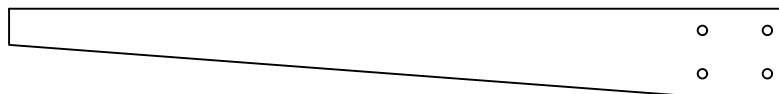

TAPER BOX OUTRIGGER