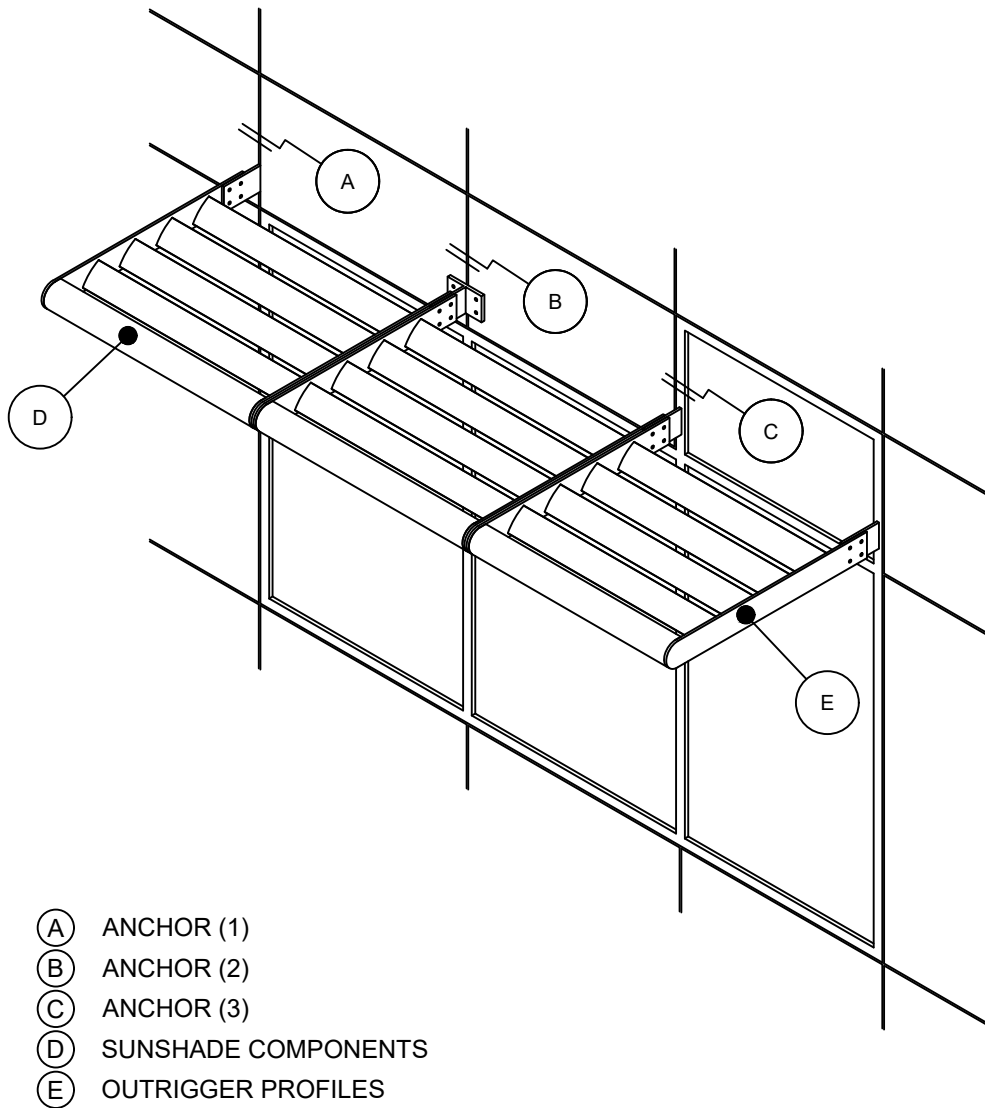

**EXTERIOR SUN CONTROL DEVICE (ROUND BLADES)**

## ANCHOR (1)

## DETAIL A

**NOTE:**

**LOAD BEARING WALL COMPONENTS OF EITHER: 16GA STEEL STUDS, STRUCTURAL MEMBERS, MINIMUM 5/8" PLYWOOD OR CONCRETE. GYPSUM BOARD AND CEMENT BOARD ARE NOT A STRUCTURAL COMPONENT.**

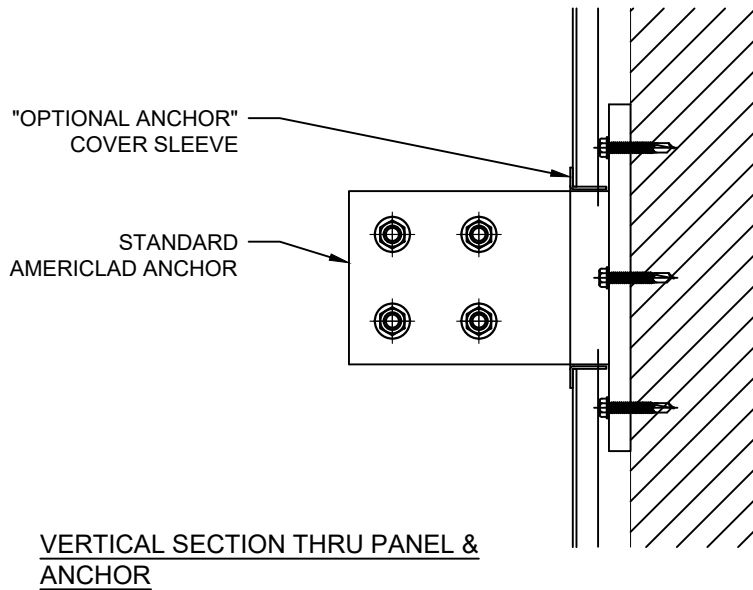
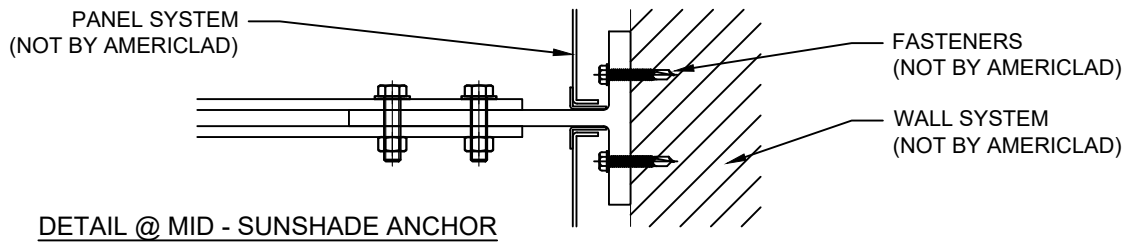
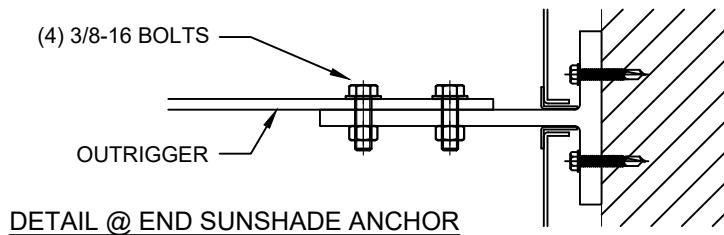

## ANCHOR (2)

## DETAIL B

**NOTE:**

**LOAD BEARING WALL COMPONENTS OF EITHER: 16GA STEEL STUDS, STRUCTURAL MEMBERS, MINIMUM 5/8" PLYWOOD OR CONCRETE. GYPSUM BOARD AND CEMENT BOARD ARE NOT A STRUCTURAL COMPONENT.**

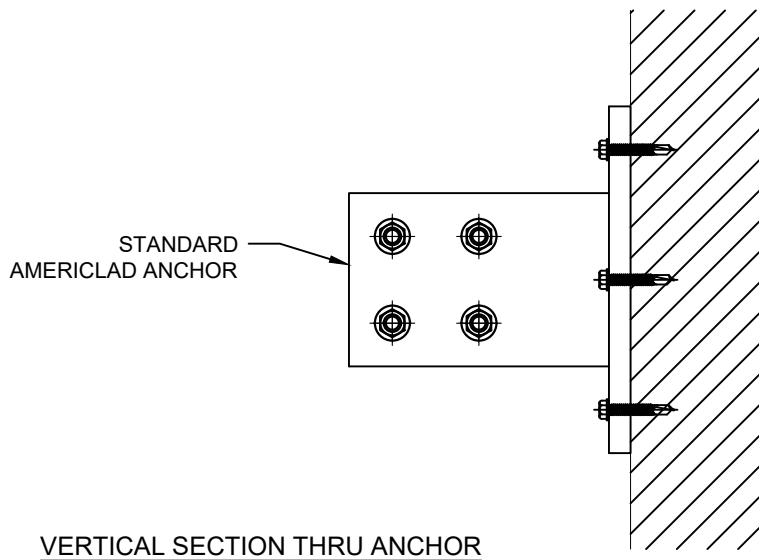
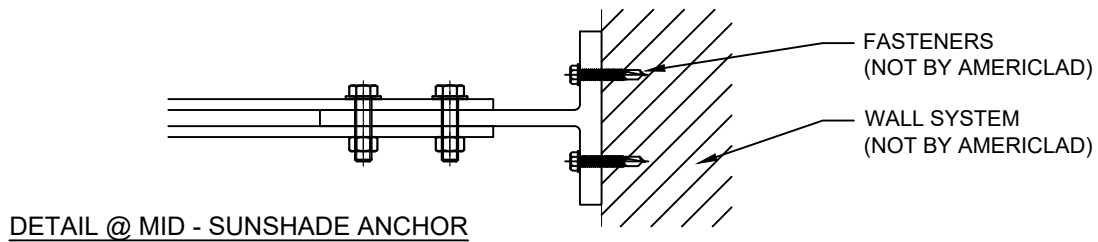
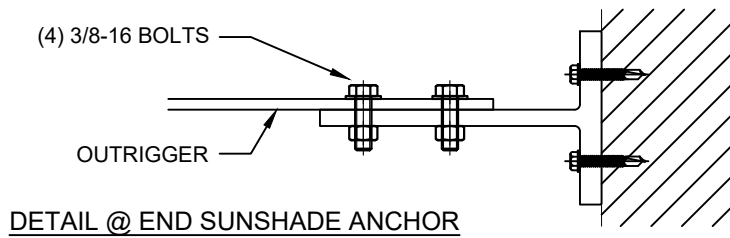

## ANCHOR (3)

## DETAIL C

**NOTE:**

**LOAD BEARING WALL COMPONENTS OF EITHER: 16GA STEEL STUDS, STRUCTURAL MEMBERS, MINIMUM 5/8" PLYWOOD OR CONCRETE. GYPSUM BOARD AND CEMENT BOARD ARE NOT A STRUCTURAL COMPONENT.**

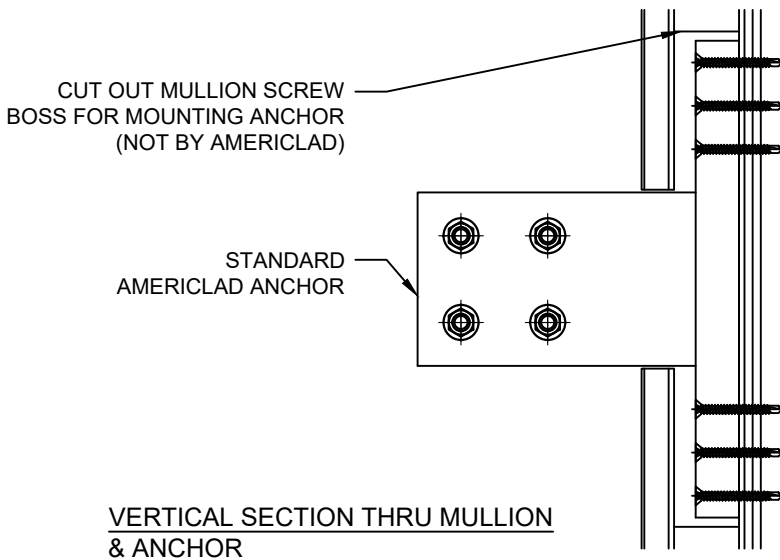
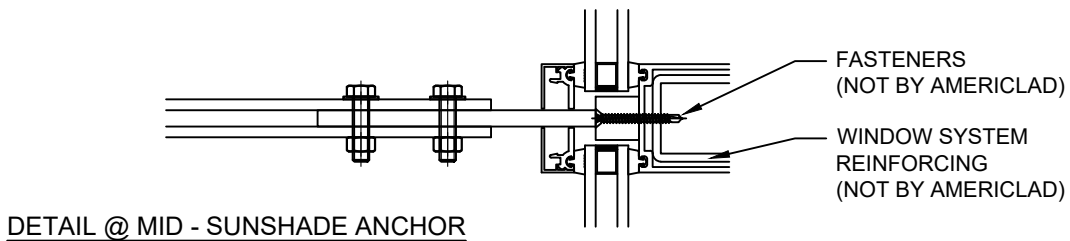
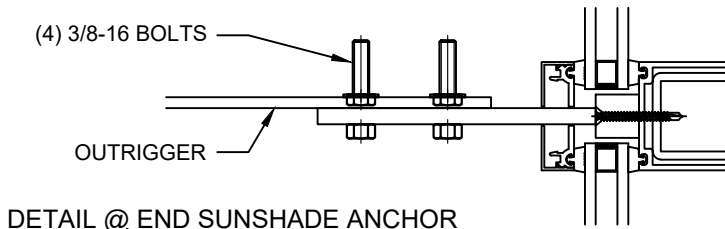

## SUNSHADE COMPONENTS

## DETAIL D

**NOTE:**

**LOAD BEARING WALL COMPONENTS OF EITHER: 16GA STEEL STUDS, STRUCTURAL MEMBERS, MINIMUM 5/8" PLYWOOD OR CONCRETE. GYPSUM BOARD AND CEMENT BOARD ARE NOT A STRUCTURAL COMPONENT.**

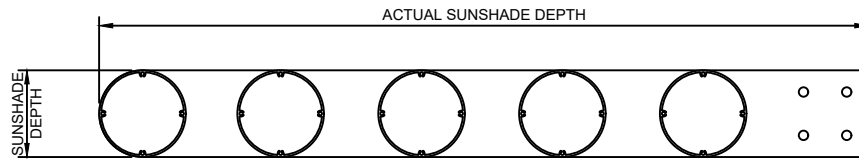

STANDARD AIRFOILS

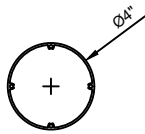

4" DIA. ROUND AIRFOIL

STANDARD FASCIAS

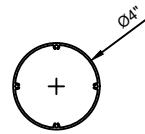

4" DIA. ROUND FASCIA

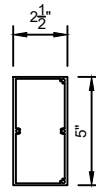

RECTANGULAR FASCIA

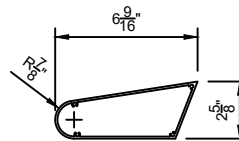

WEDGE FASCIA

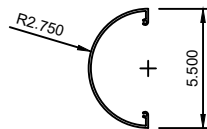

BULLNOSE FASCIA

CUSTOM SIZES ARE ALSO AVAILABLE UPON REQUEST

**OUTRIGGER PROFILES****DETAIL E****NOTE:**

**LOAD BEARING WALL COMPONENTS OF EITHER: 16GA STEEL STUDS, STRUCTURAL MEMBERS, MINIMUM 5/8" PLYWOOD OR CONCRETE. GYPSUM BOARD AND CEMENT BOARD ARE NOT A STRUCTURAL COMPONENT.**

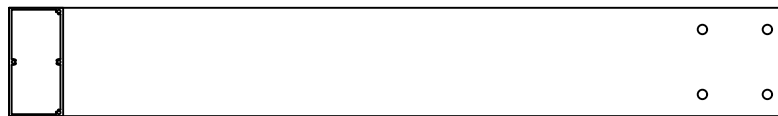

BOX OUTRIGGER

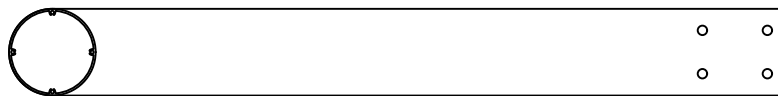

ROUND OUTRIGGER

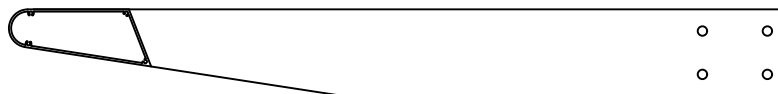

QUARTER ROUND OUTRIGGER



TAPER QUARTER ROUND OUTRIGGER



TAPER BOX OUTRIGGER